

Your Name Goes Here
 Alyssa Wells

2020 Mammal March

Mammal Madness
 mammalssuck.blogspot.com

MMM created and directed by
 Prof Katie Hinde, Arizona State University
 v1.0 (eng bracket design by Wm Nickley)

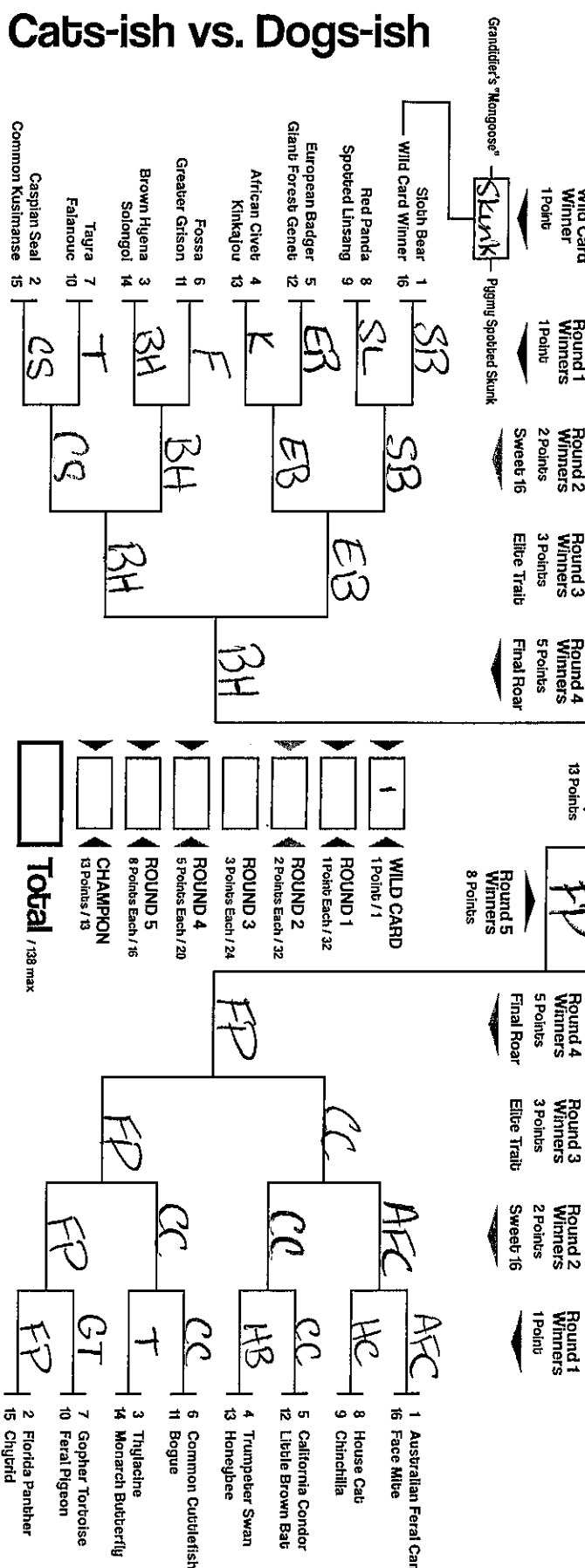
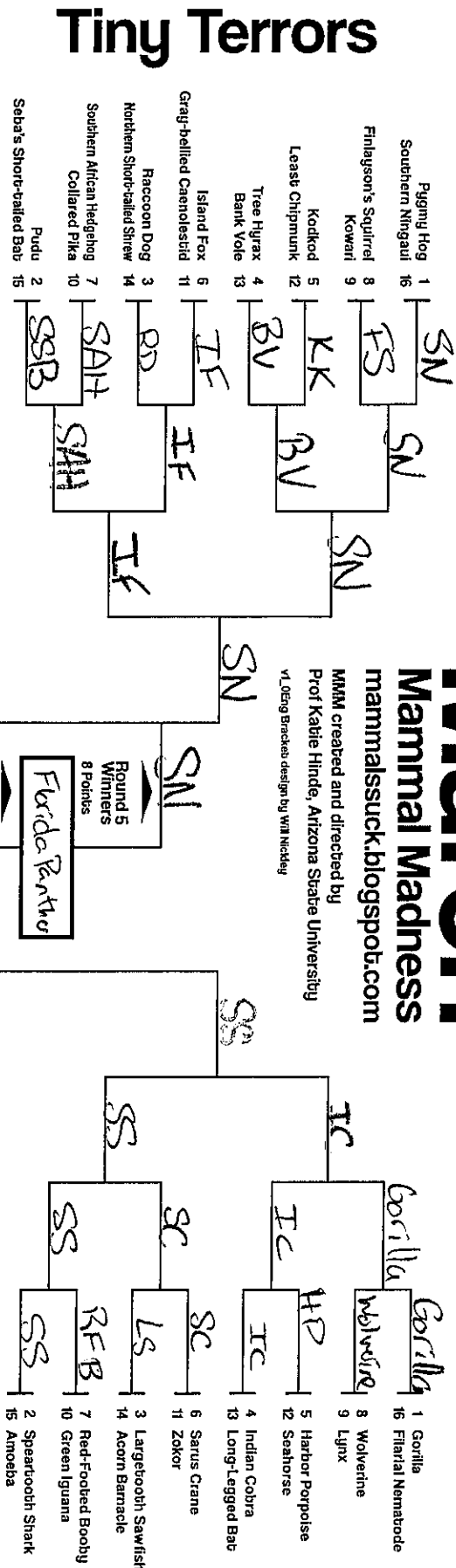

Champion 13 Points: Florida Panther

Round 5 Winners 8 Points: SN

Round 4 Winners 5 Points: FP

Round 3 Winners 3 Points: FP

Round 2 Winners 2 Points: FP

Round 1 Winner 1 Point: 1

WILD CARD 1 Point / 1

ROUND 1 1 Point Each / 32

ROUND 2 2 Points Each / 32

ROUND 3 3 Points Each / 24

ROUND 4 5 Points Each / 20

ROUND 5 8 Points Each / 16

CHAMPION 13 Points / 13

Total / 138 max

Double Trouble

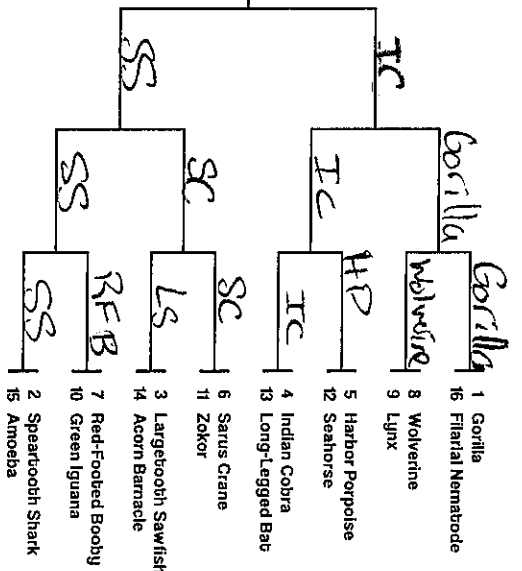

AnthropoSCENE

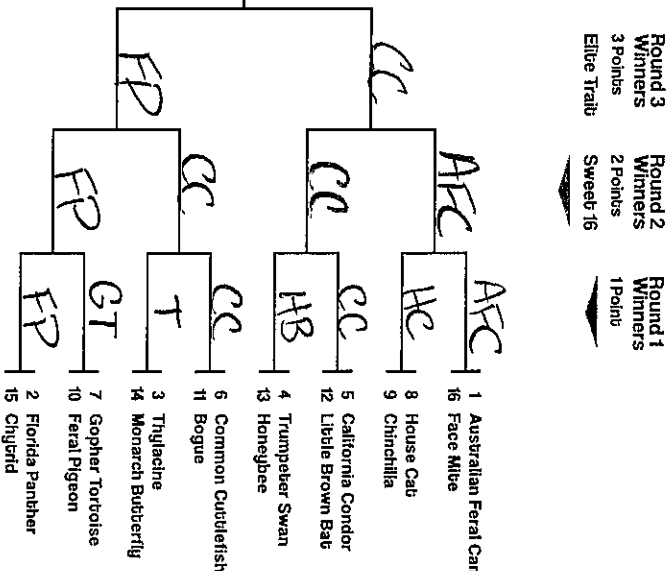

ETIM AITL

Your Name Goes Here

2020

Mammal March

Mammal Madness

mammalsuck.blogspot.com

MMM created and directed by Prof Katie Hinde, Arizona State University

v.1.0eng Bracket design by WIN NICKLE

Tiny Terrors

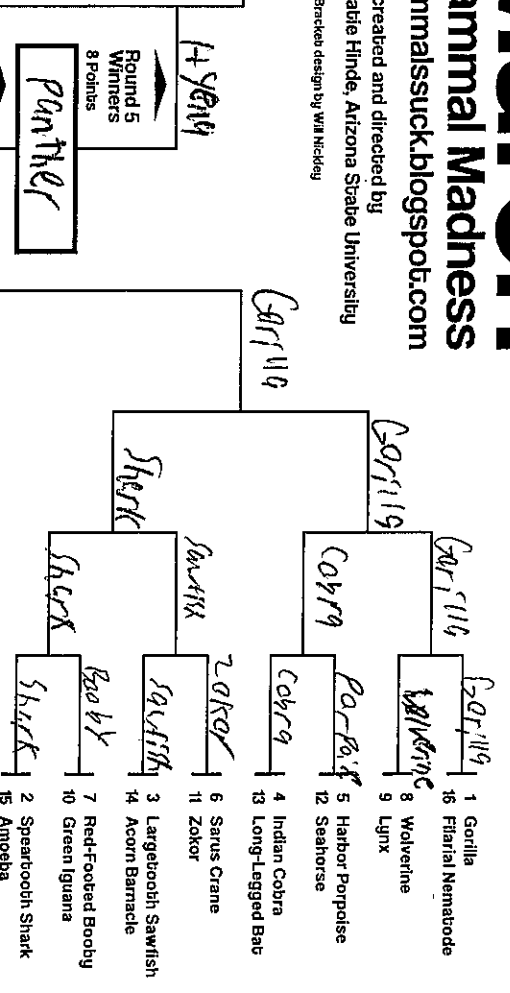
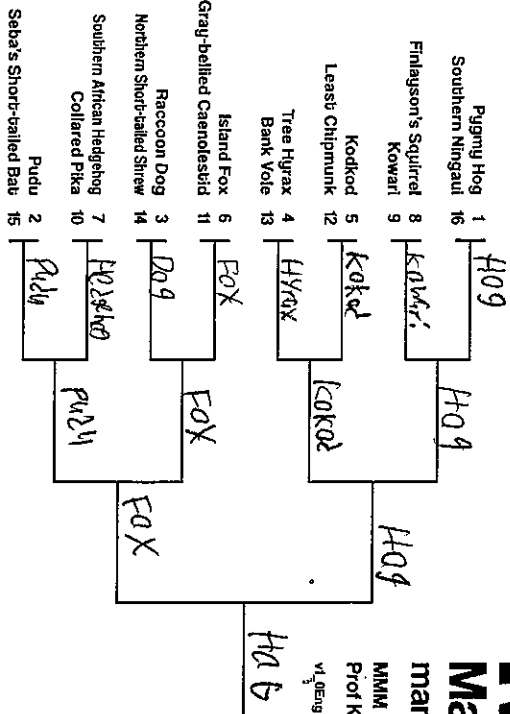

Cats-ish vs. Dogs-ish

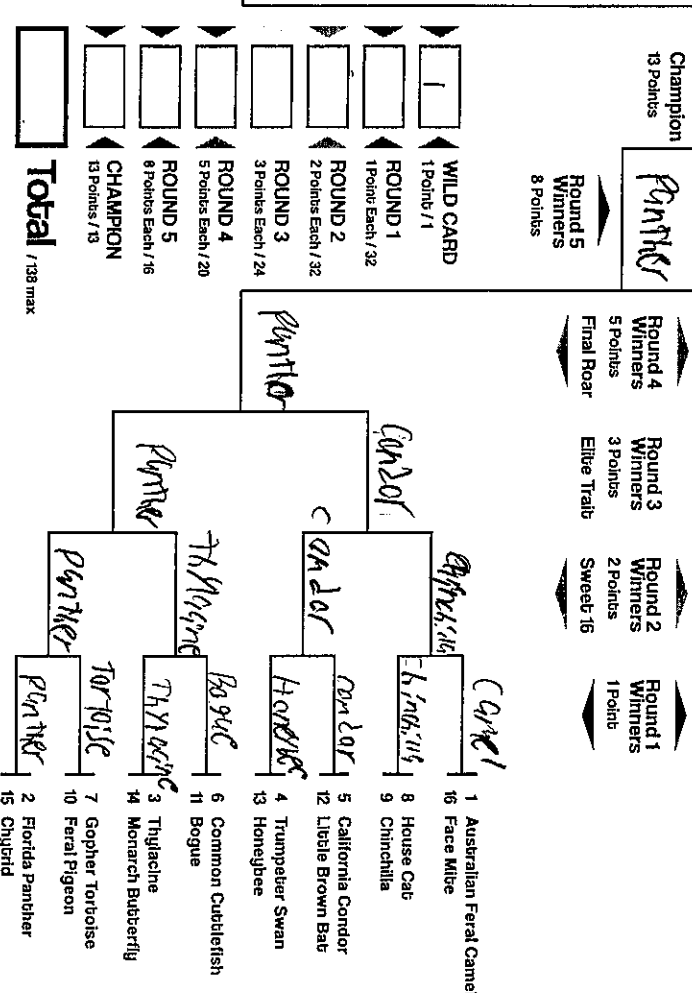
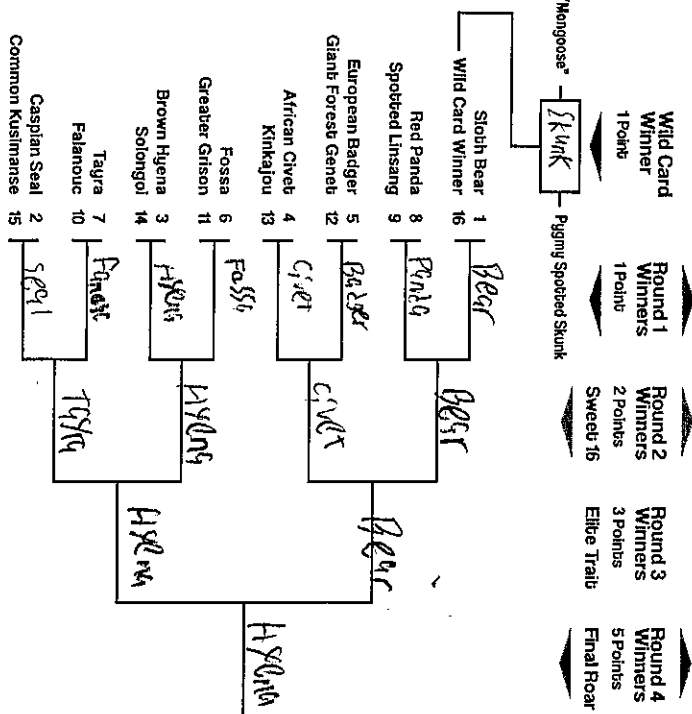

AnthroSCENE

Double Trouble

WILD CARD	1 Point / 1
ROUND 1	1 Point Each / 32
ROUND 2	2 Points Each / 32
ROUND 3	3 Points Each / 24
ROUND 4	5 Points Each / 20
ROUND 5	8 Points Each / 16
CHAMPION	13 Points / 13
Total	138 max

Anna An Garski
 Your Name Goes Here

2020 Mammal March

Mammal Madness
 mammalssuck.blogspot.com

MMM created and directed by
 Prof Katie Hinde, Arizona State University
 v1.0 (Eng Bracket design by Will Nickles)

Tiny Terrors

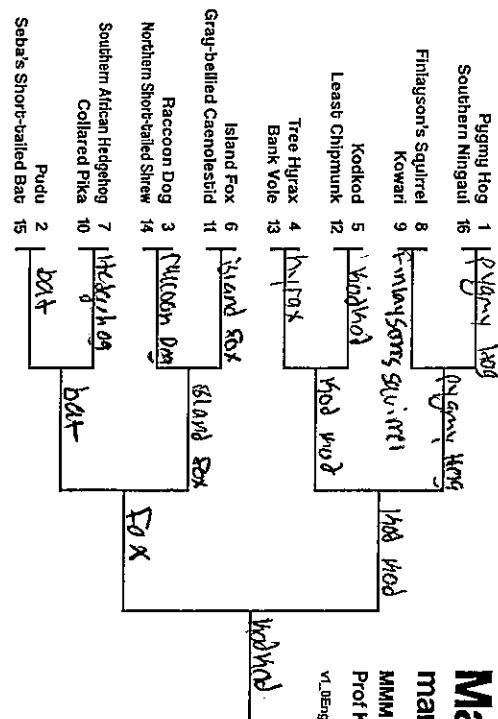

Cats-ish vs. Dogs-ish

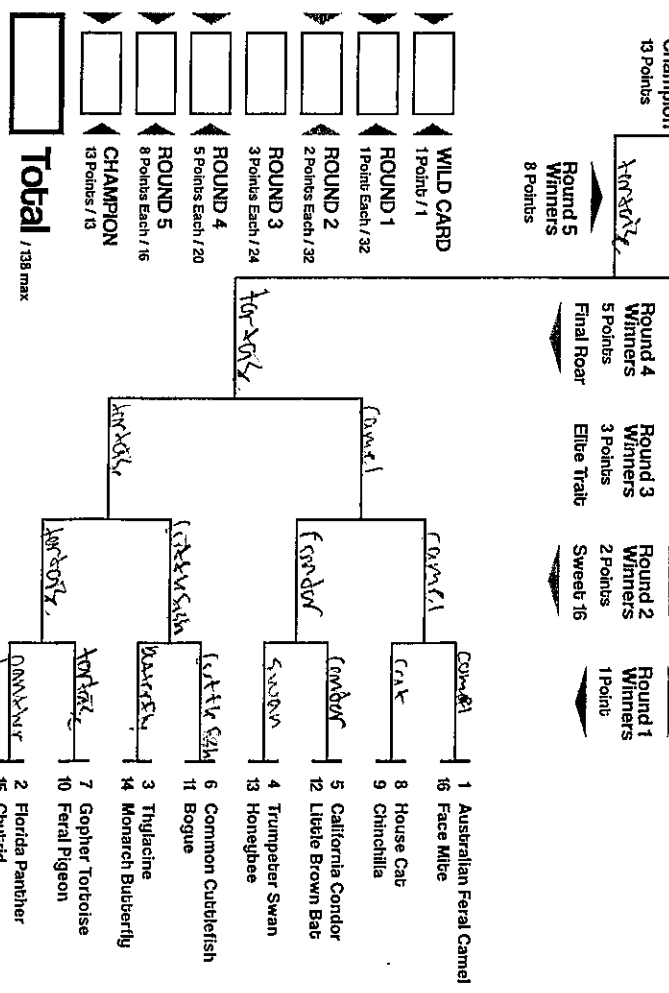
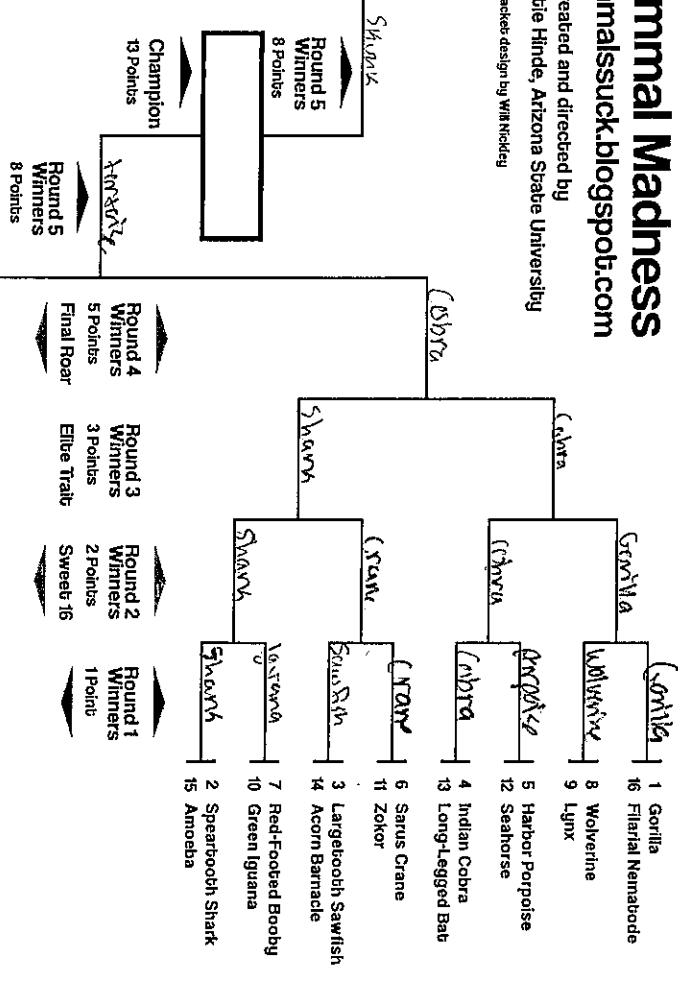
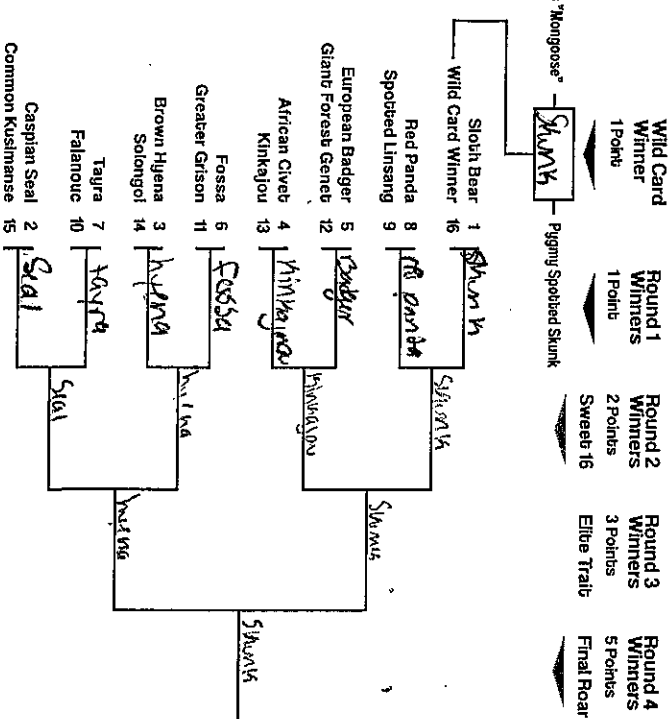

AnthropoSCENE

Double Trouble

WILD CARD
 1 Point / 1
 ROUND 1
 1 Point Each / 32
 ROUND 2
 2 Points Each / 32
 ROUND 3
 3 Points Each / 24
 ROUND 4
 5 Points Each / 20
 ROUND 5
 8 Points Each / 16
 CHAMPION
 13 Points / 13
 Total / 138 max

Your Name Goes Here

2020 Mammal March

Mammal Madness

mammalssuck.blogspot.com
MMM created and directed by
Prof Katie Hinde, Arizona State University
v. Long Bracket design by Will Nidley

Tiny Terrors

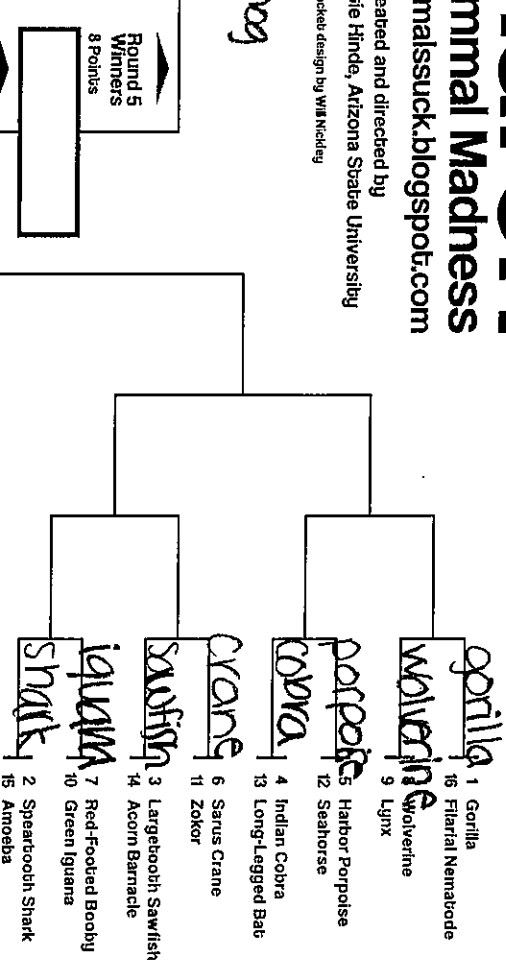
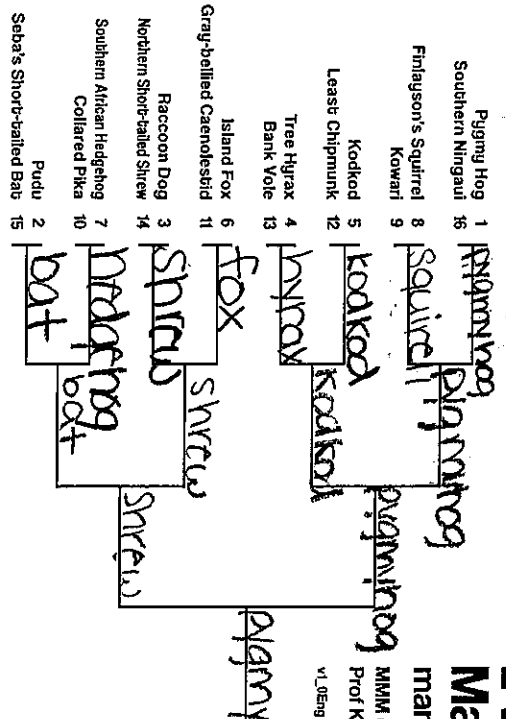

Cats-ish vs. Dogs-ish

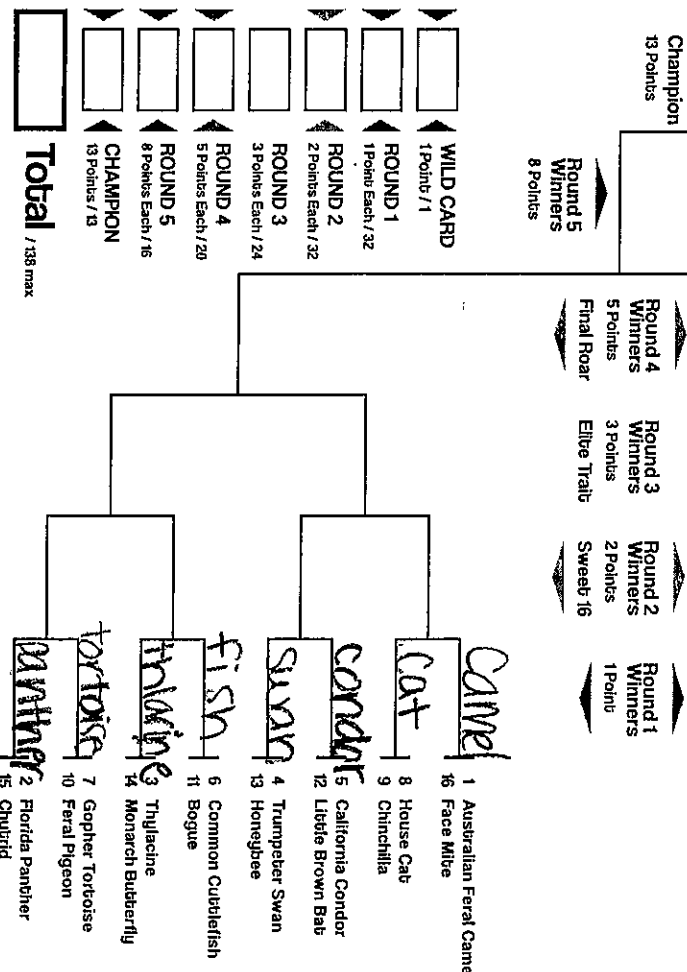
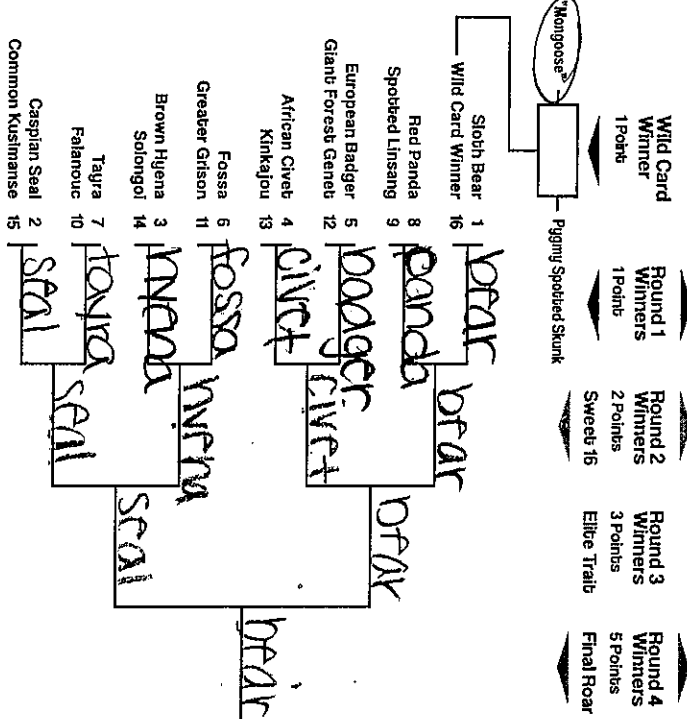

Double Trouble

AnthroPOSCENE

CT

Your Name Goes Here

2020

Mammal March

mammalstuck.blogspot.com

MMM created and directed by
Prof Katie Hinde, Arizona State University
V. Deng Bracket design by Will Nickley

Tiny Terrors

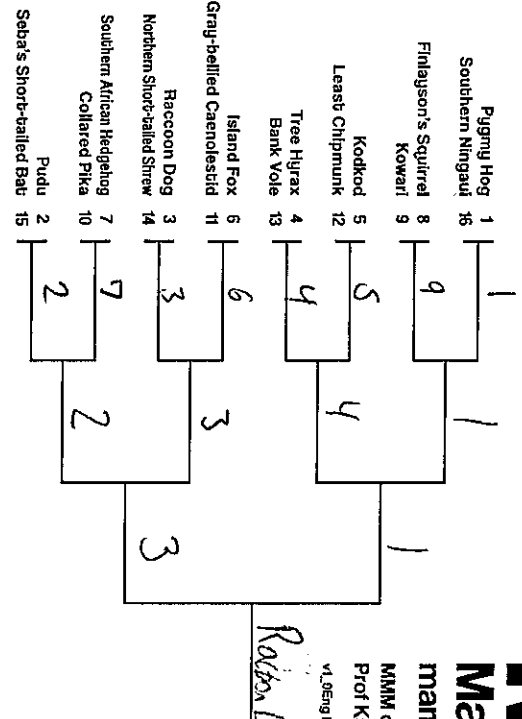

Cats-ish vs. Dogs-ish

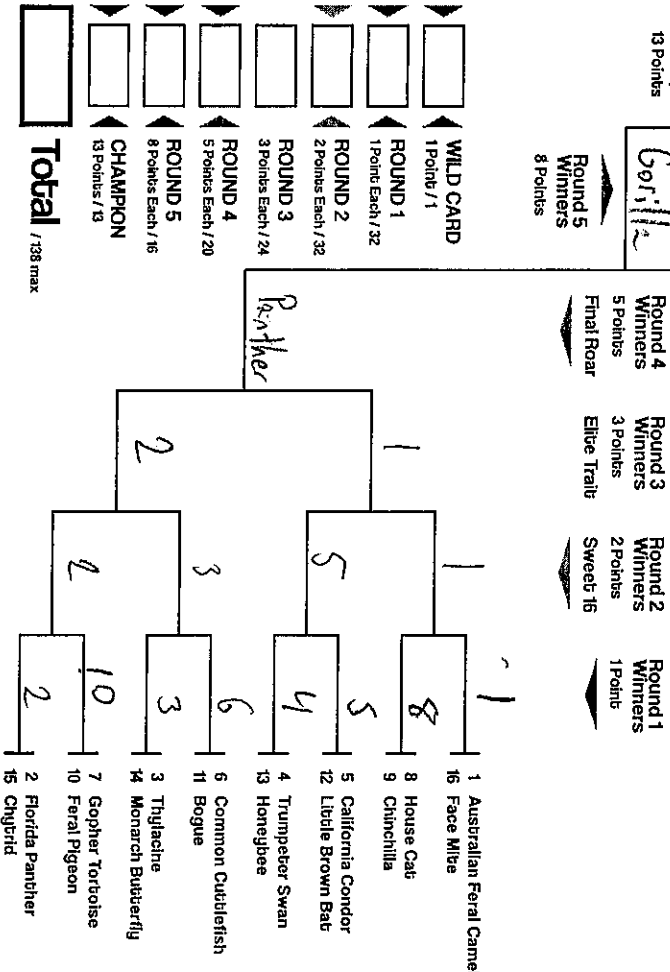
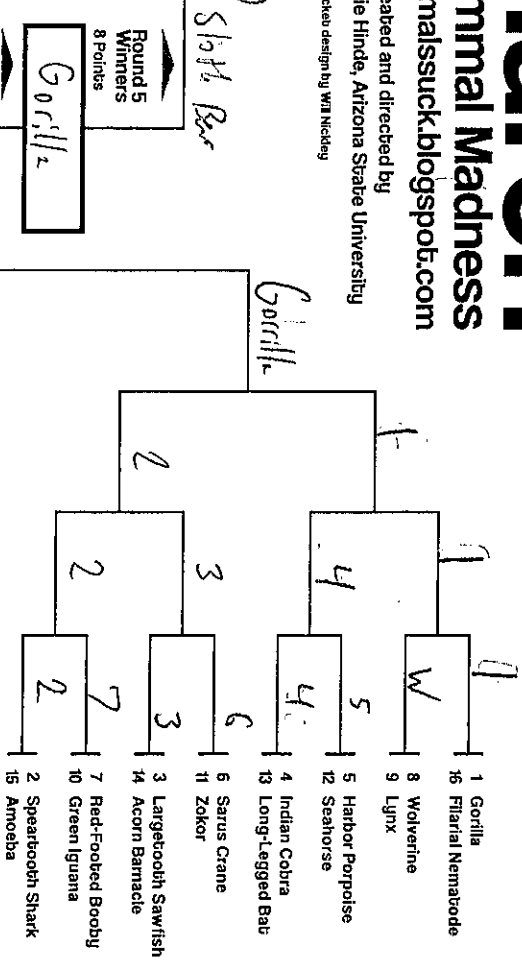
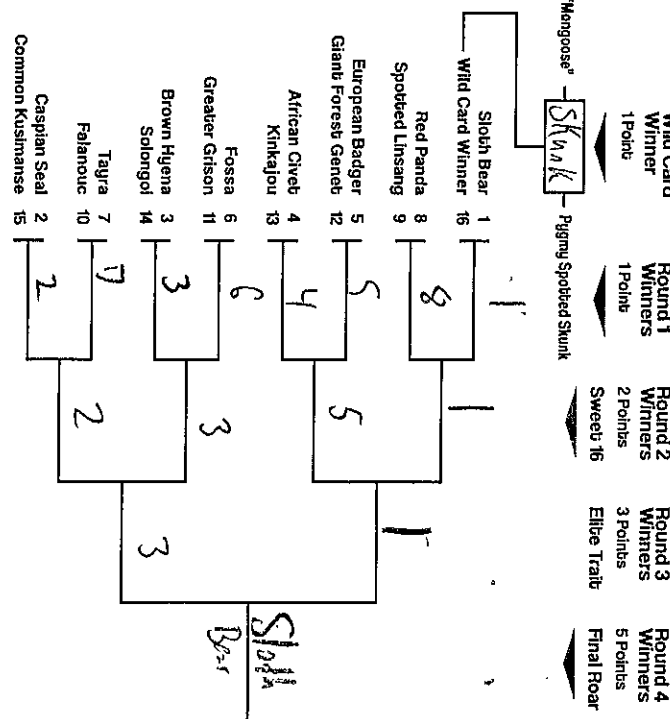

AnthroPOSCENE

Double Trouble

WILD CARD
1 Point / 1

ROUND 1
1 Point Each / 32

ROUND 2
2 Points Each / 32

ROUND 3
3 Points Each / 24

ROUND 4
5 Points Each / 20

ROUND 5
8 Points Each / 16

CHAMPION
13 Points / 13

Total / 138 max

Marie Howard

Your Name Goes Here

2020

Mammal March

Mammal Madness
mammalsuck.blogspot.com

MMW created and directed by
Prof Katie Hinde, Arizona State University
V1.0 Eng Bracket design by Will Nickley

Tiny Terrors

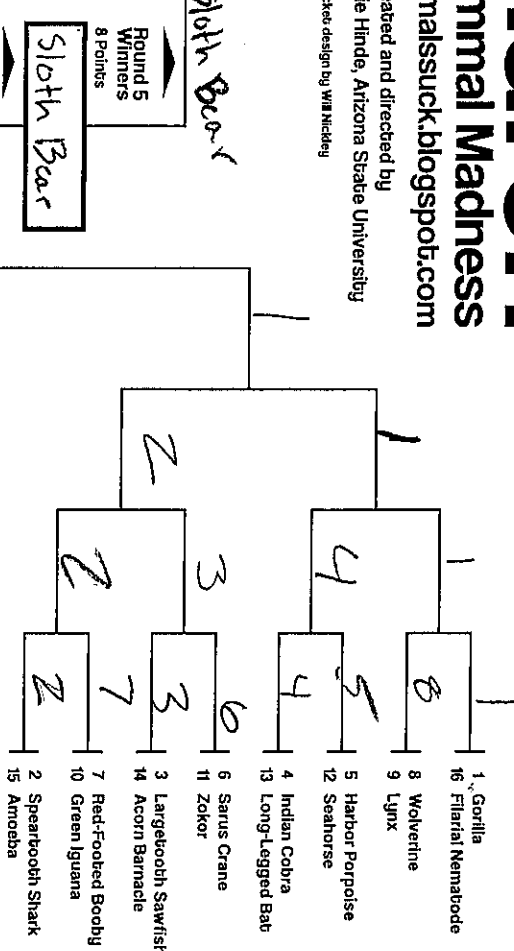
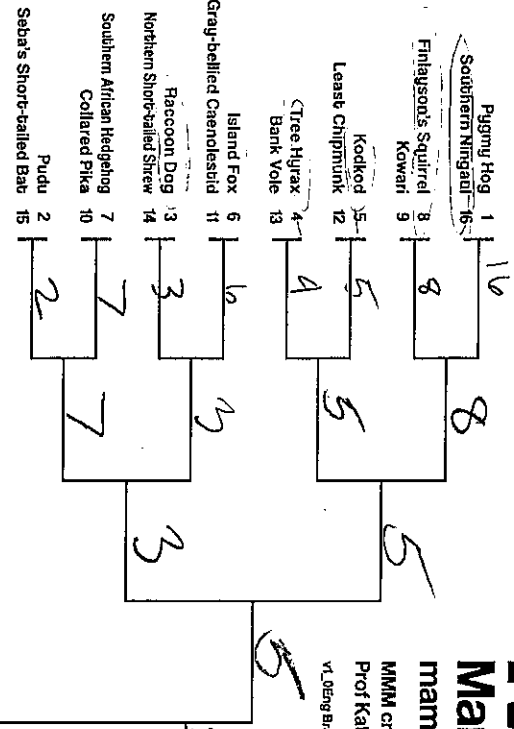

Cats-ish vs. Dogs-ish

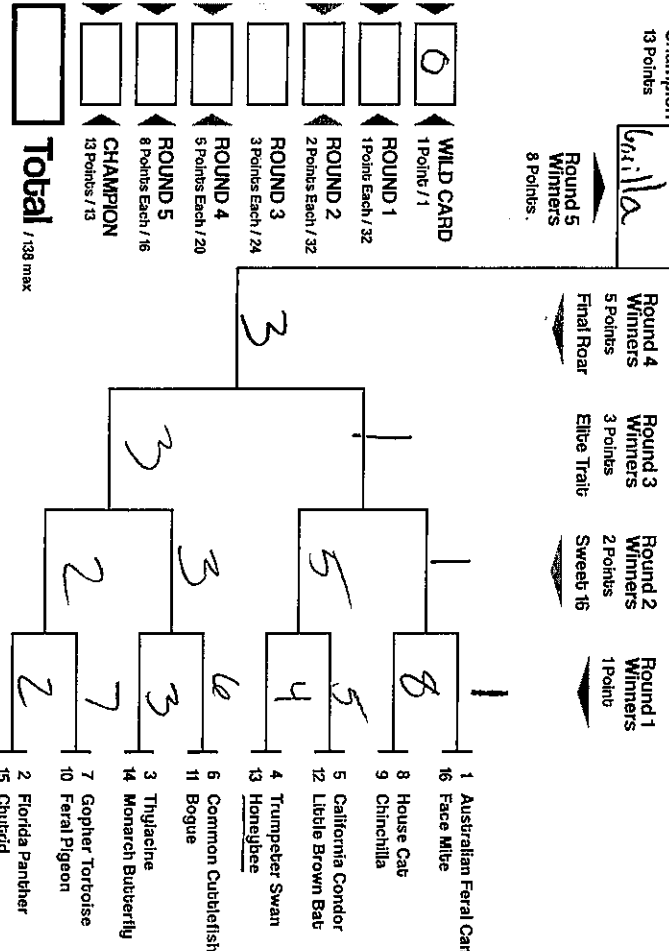
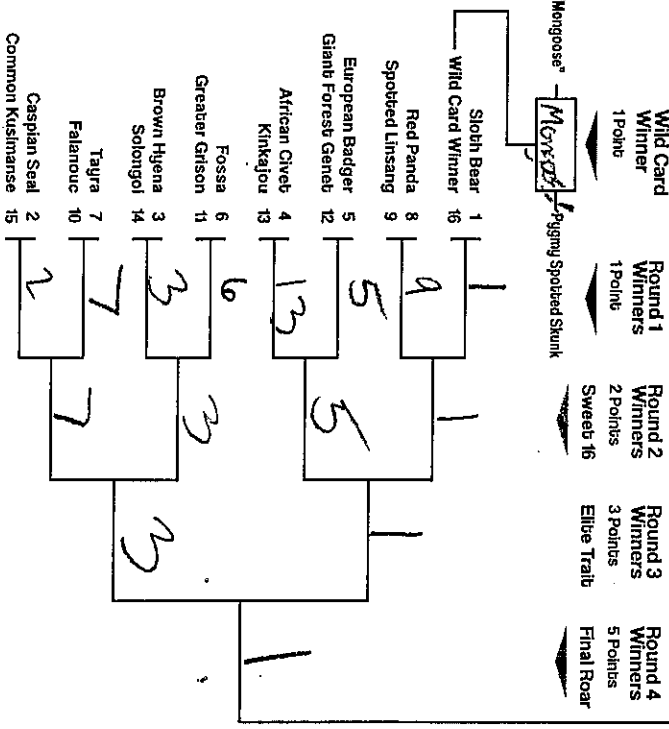

AnthroPOSCENE

Double Trouble

WILD CARD
1 Point / 1
 ROUND 1
1 Point Each / 32
 ROUND 2
2 Points Each / 32
 ROUND 3
3 Points Each / 24
 ROUND 4
5 Points Each / 20
 ROUND 5
8 Points Each / 16
 CHAMPION
13 Points / 13
 Total / 138 max

Josiah Holler

Your Name Goes Here

2020

March

Mammal Madness

mammalssuck.blogspot.com

MMM created and directed by
Prof Kabie Hinde, Arizona State University
v1.0 Being Bracket design by Wm Neckley

Tiny Terrors

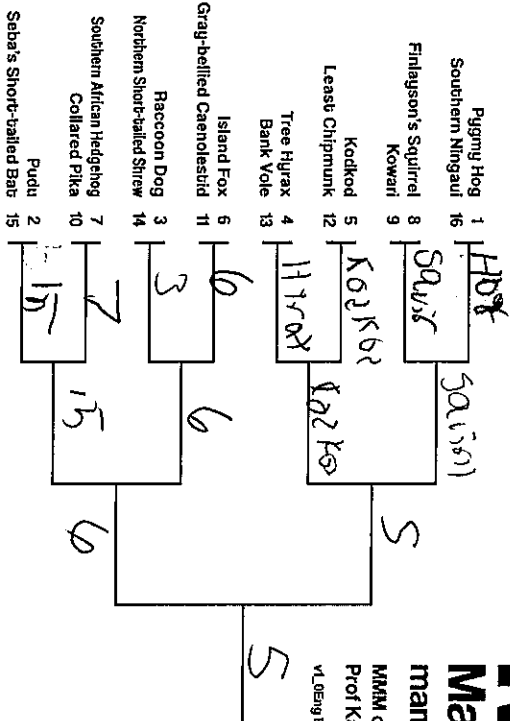

Cats-ish vs. Dogs-ish

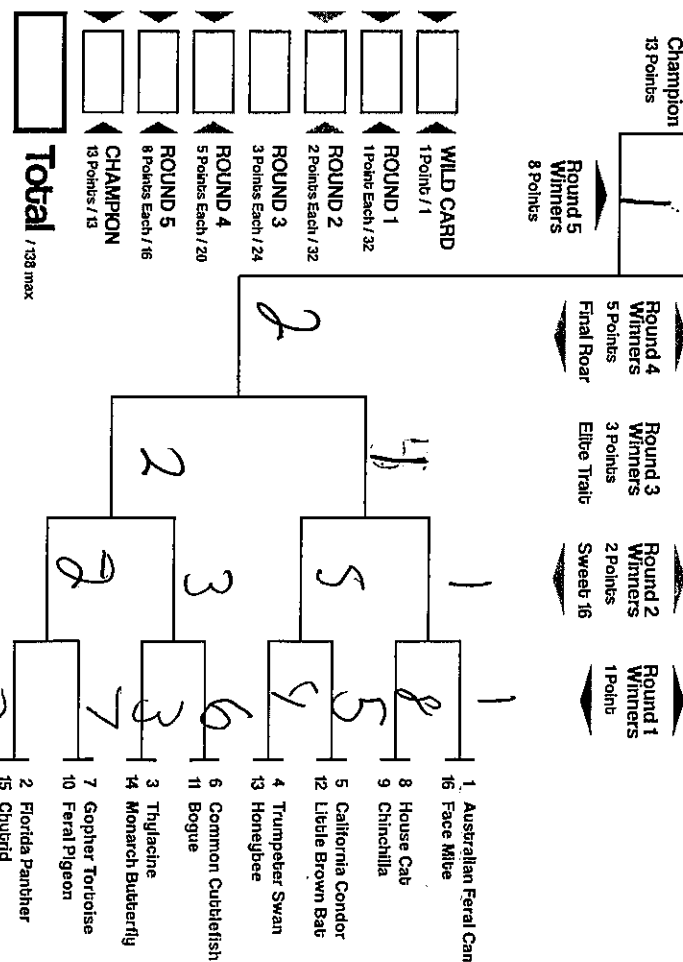
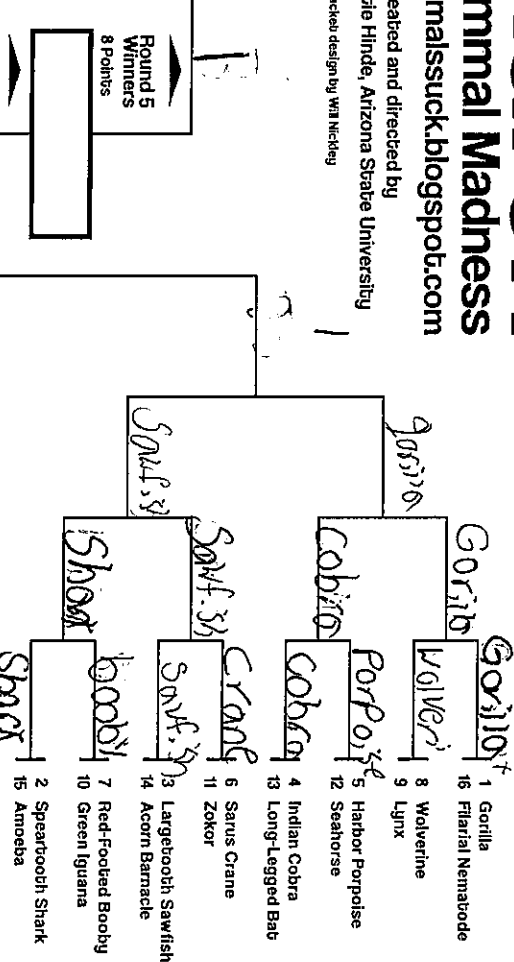
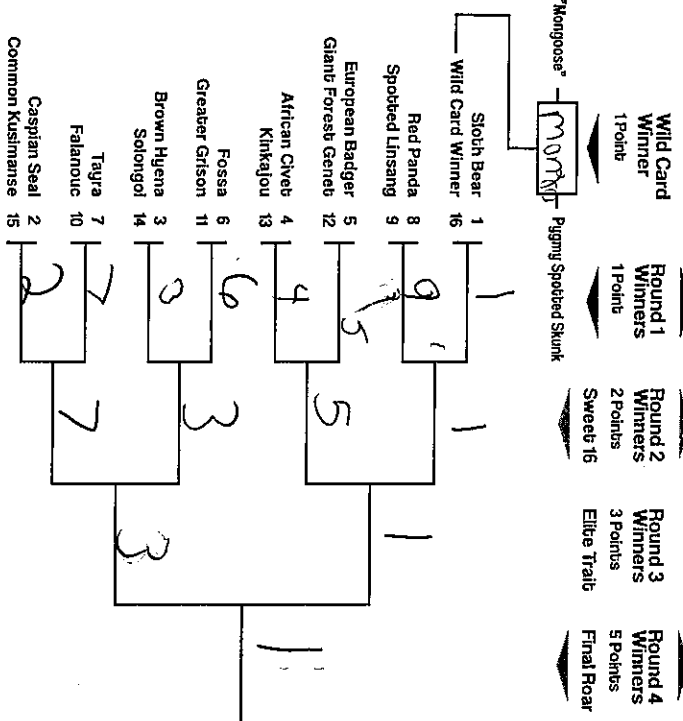

AnthropoSCENE

Double Trouble

WILD CARD
1 Point / 1
ROUND 1
1 Point Each / 32
ROUND 2
2 Points Each / 32
ROUND 3
3 Points Each / 24
ROUND 4
5 Points Each / 20
ROUND 5
8 Points Each / 16
CHAMPION
13 Points / 13
Total / 138 max

Sold via B211
Your Name Goes Here

2020 Mammal March

Mammal Madness
mammalstuck.blogspot.com

MMM created and directed by
Prof Katie Hinde, Arizona State University
VLEing Brackets design by Will Nickley

Tiny Terrors

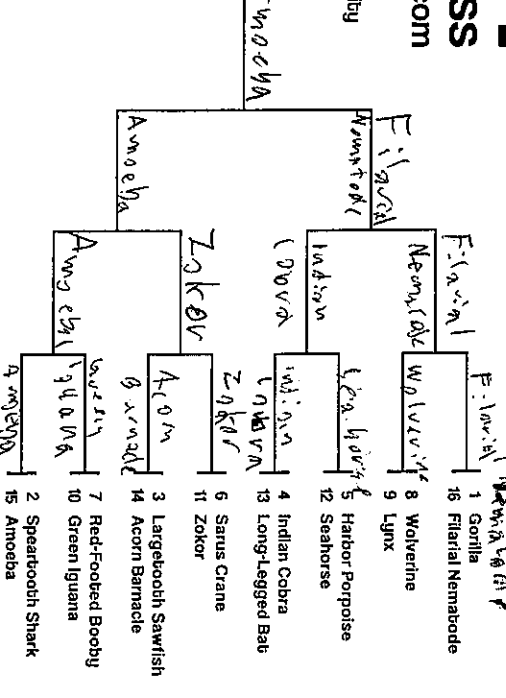
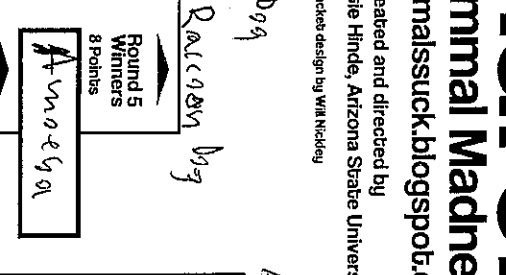
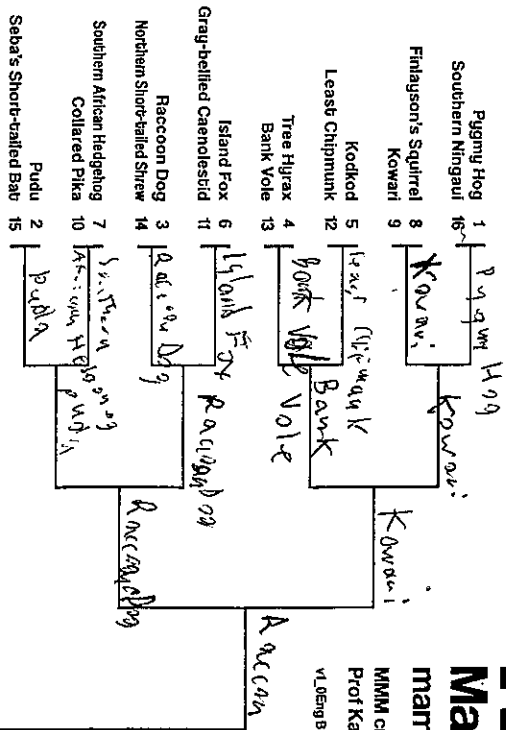

Cats-ish vs. Dogs-ish

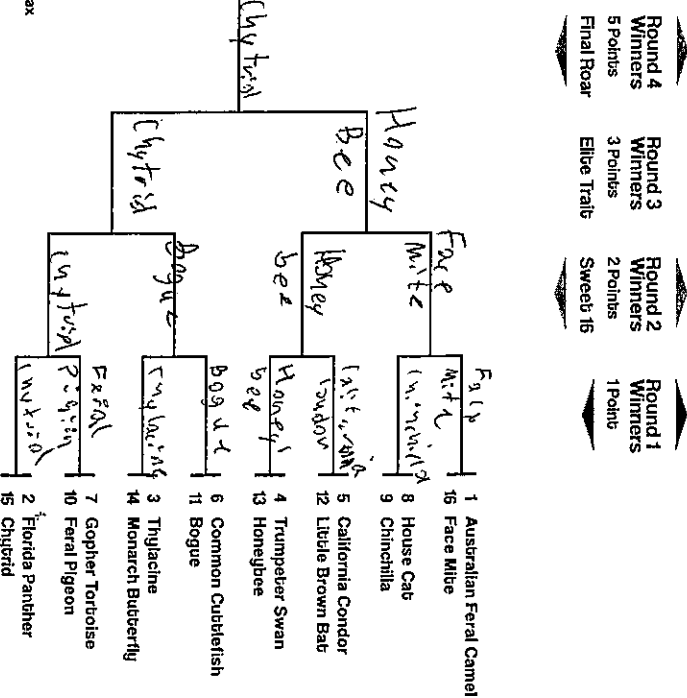
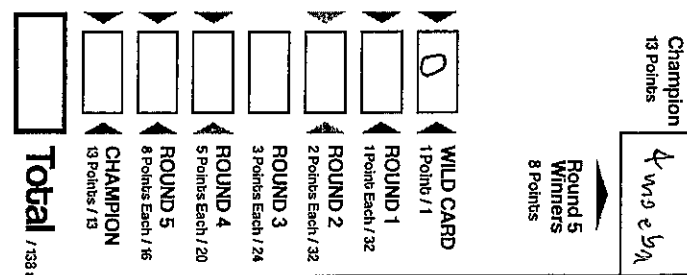
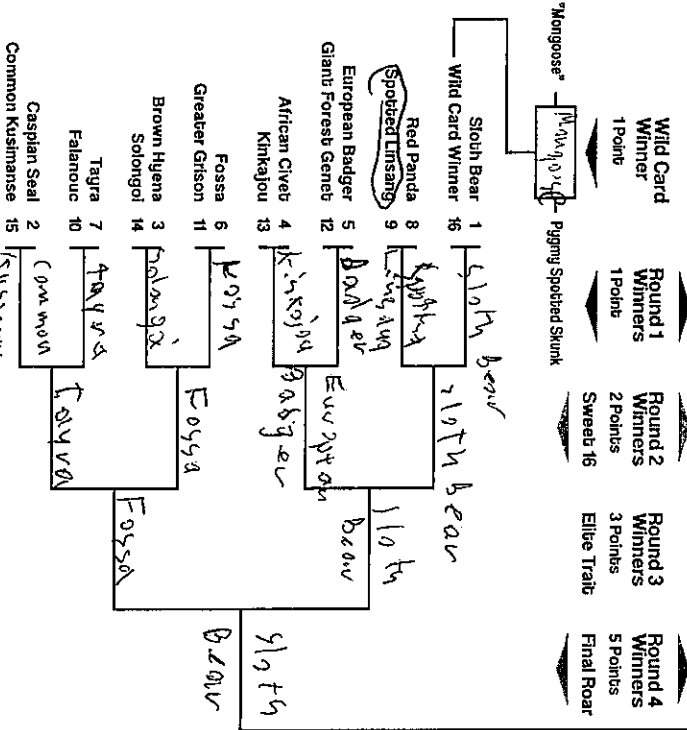

AnthropoSCENE

Double Trouble



Luke Corner

Your Name Goes Here

2020

Mamarch

Mammal Madness

mammalstuck.blogspot.com

MMM created and directed by Prof Katie Hinde, Arizona State University
v1_Deng Bracket design by Will Nickley

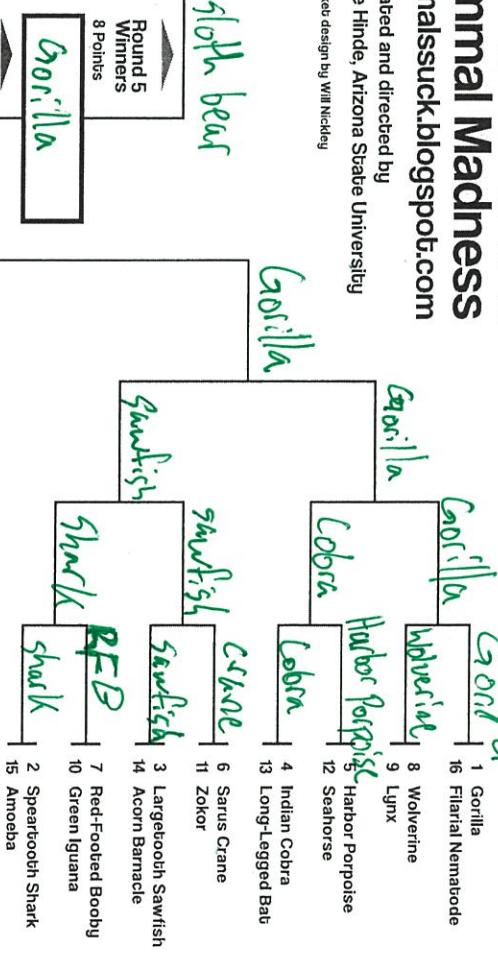
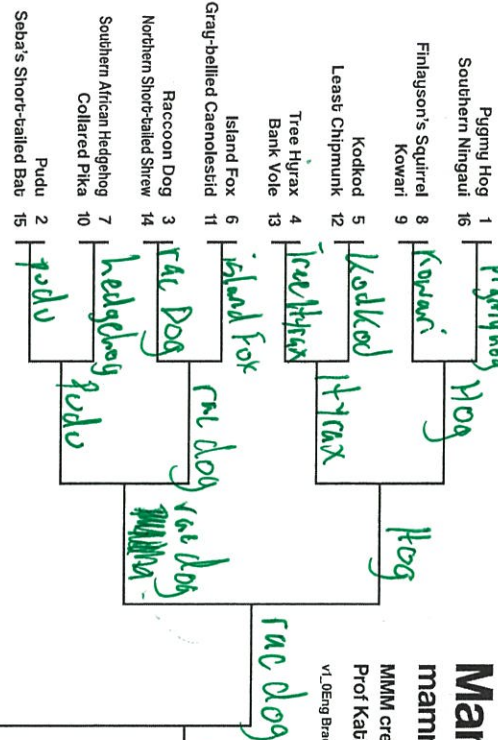

Double Trouble

Cats-ish vs. Dogs-ish

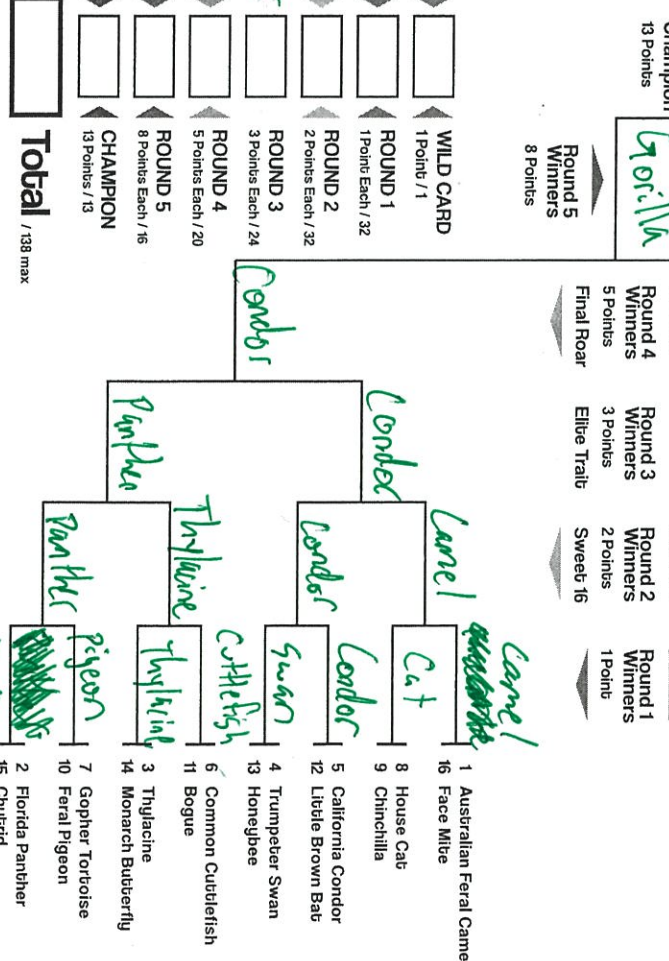
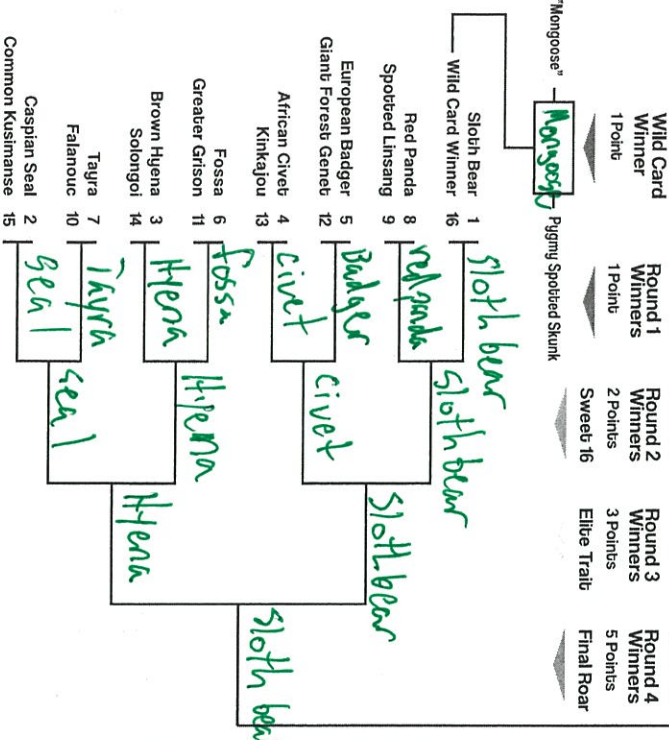

AnthroPOSCENE

WILD CARD
1 Point / 1

ROUND 1
1 Point Each / 32

ROUND 2
2 Points Each / 32

ROUND 3
3 Points Each / 24

ROUND 4
5 Points Each / 20

ROUND 5
8 Points Each / 16

CHAMPION
13 Points / 13

Total / 138 max

Notes: SM, B, H
Your Name Goes Here

2020

March

Mammal Madness

mammalsuck.blogspot.com

MMM created and directed by Prof. Katie Hinde, Arizona State University
V. Deng Bracket design by Will Nickley

Tiny Terrors

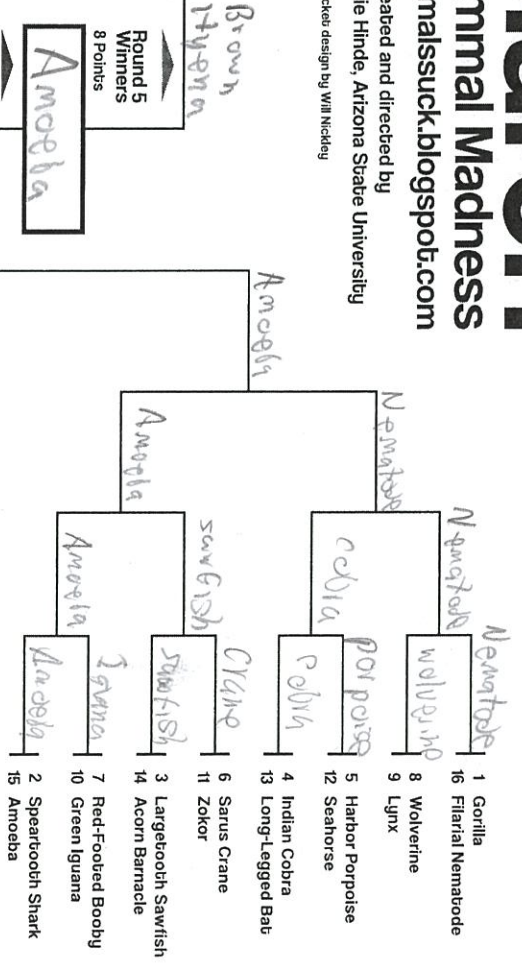
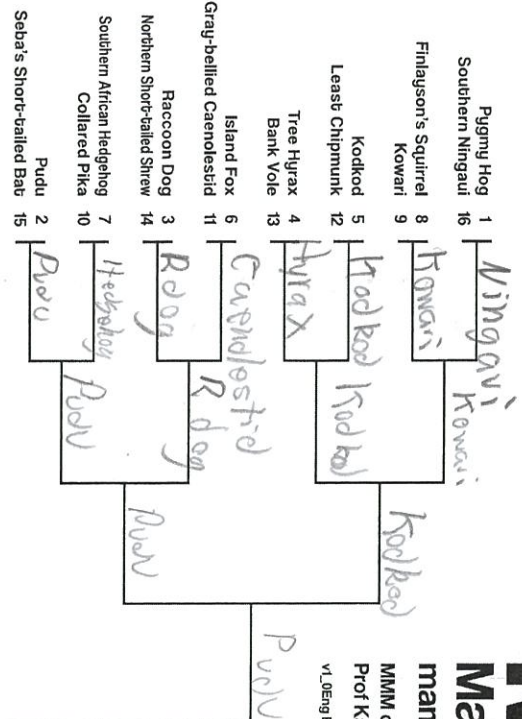

Double Trouble

Cats-ish vs. Dogs-ish

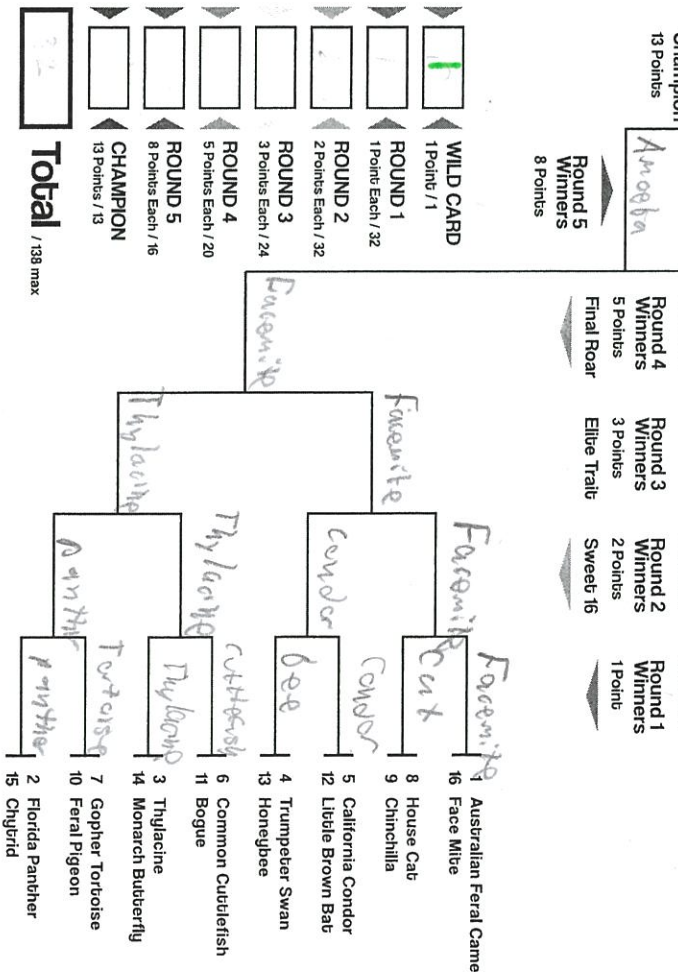
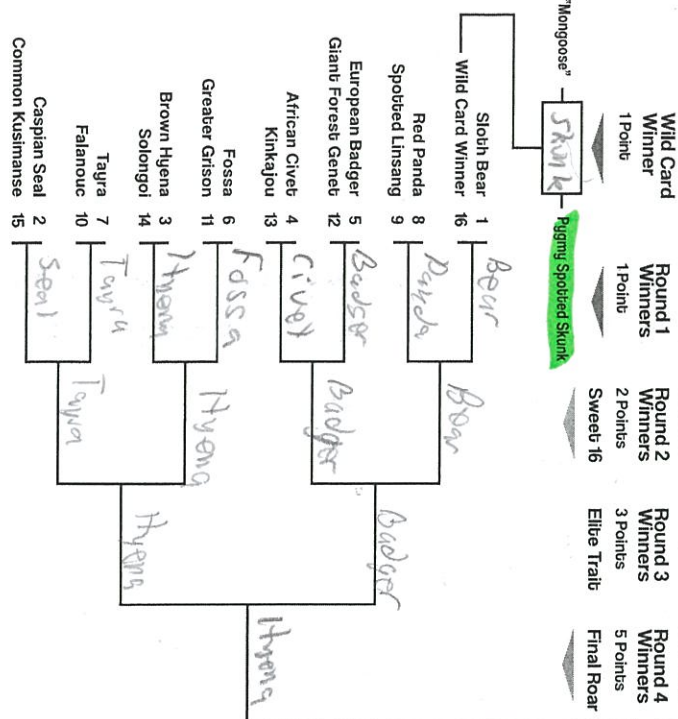

AnthroSCENE

WILD CARD
1 Point / 1
ROUND 1
1 Point Each / 32
ROUND 2
2 Points Each / 32
ROUND 3
3 Points Each / 24
ROUND 4
5 Points Each / 20
ROUND 5
8 Points Each / 16
CHAMPION
13 Points / 13
Total / 138 max

Jordyn Lawson
 Your Name Goes Here

2020 MAMMAL MARCH

Mammal Madness
 mammalssuck.blogspot.com

MMM created and directed by
 Prof Katie Hinde, Arizona State University
 v1.0ing Bracket design by Will Nickley

Tiny Terrors

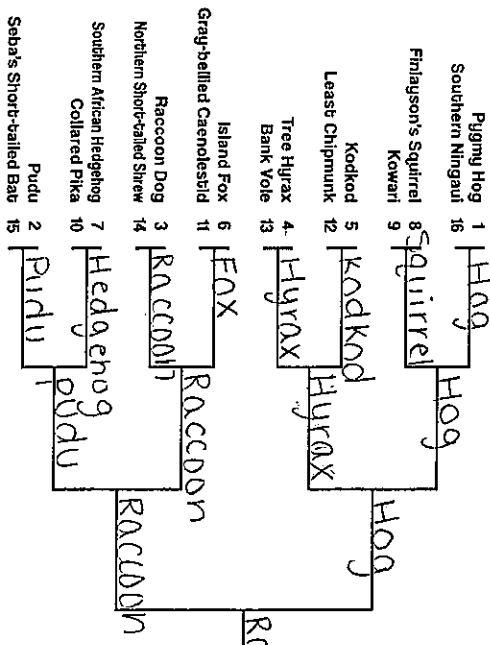

Cats-ish vs. Dogs-ish

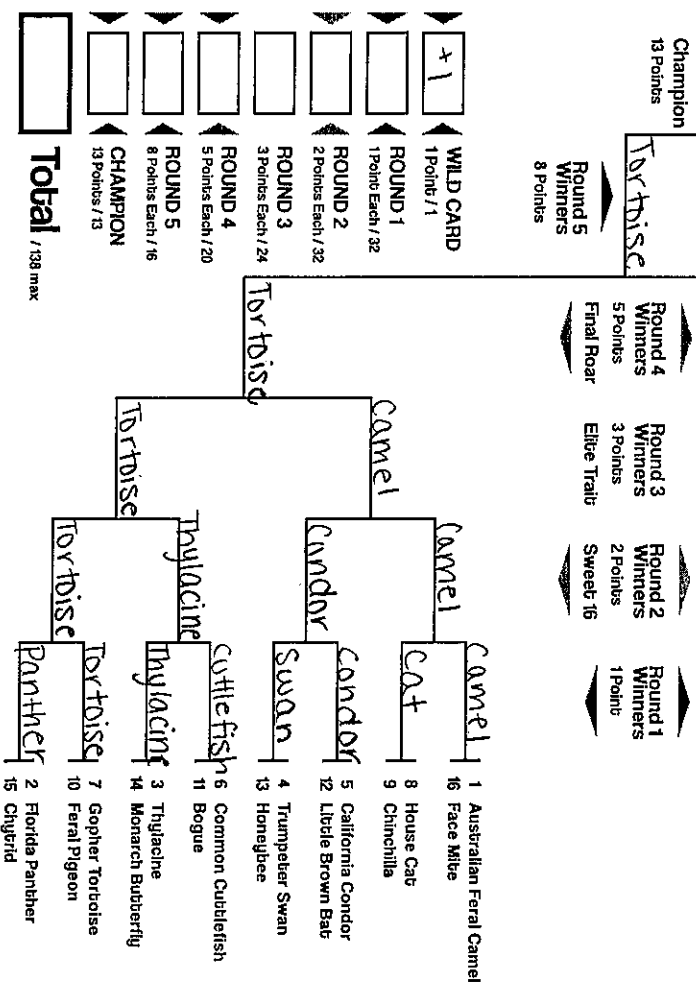
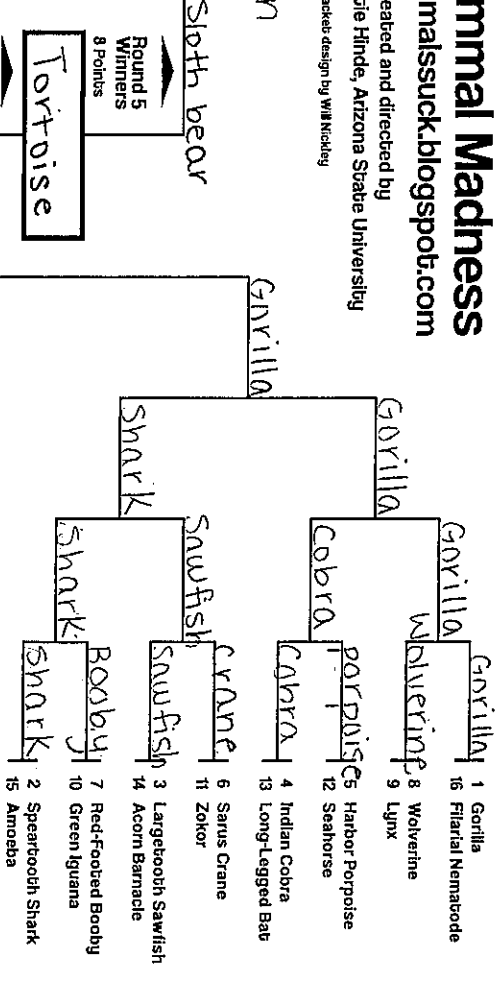
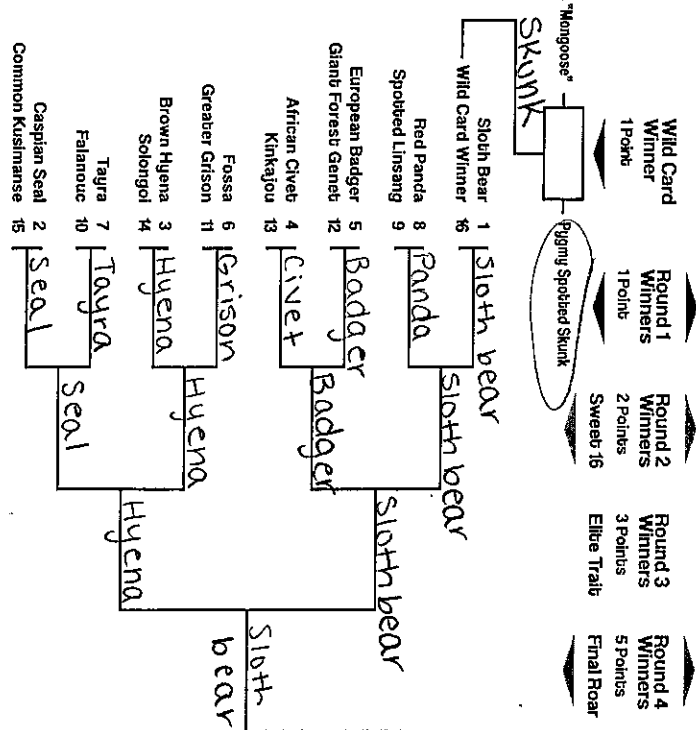

AnthroPOSCENE

Double Trouble

WILD CARD
 1 Point / 1

ROUND 1
 1 Point Each / 32

ROUND 2
 2 Points Each / 32

ROUND 3
 3 Points Each / 24

ROUND 4
 5 Points Each / 20

ROUND 5
 8 Points Each / 16

CHAMPION
 13 Points / 13

Total / 138 max

Andrew Lambert
Your Name Goes Here

2020

Mammoth March

mammalssuck.blogspot.com

MMM created and directed by Prof Katie Hinde, Arizona State University
V. Long Brackets design by Will Middle

Tiny Terrors

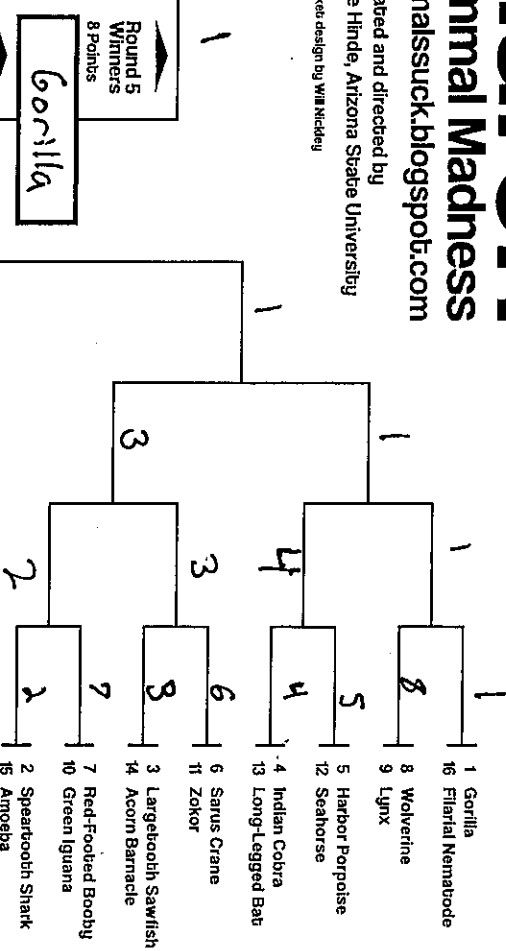
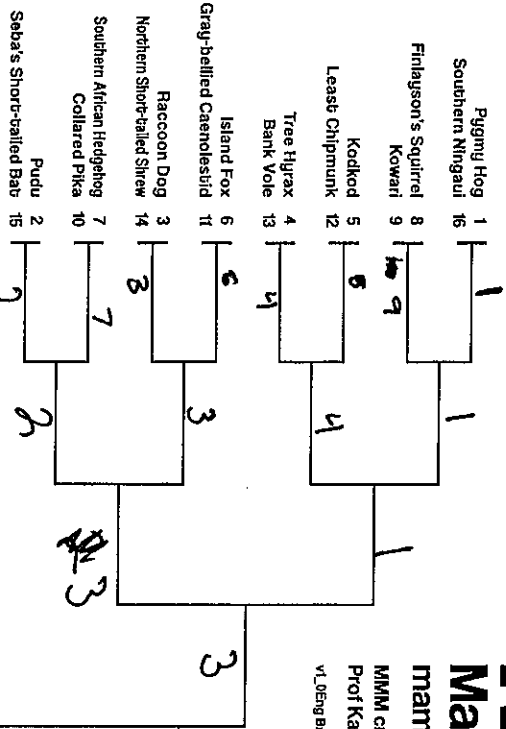

Double Trouble

Cats-ish vs. Dogs-ish

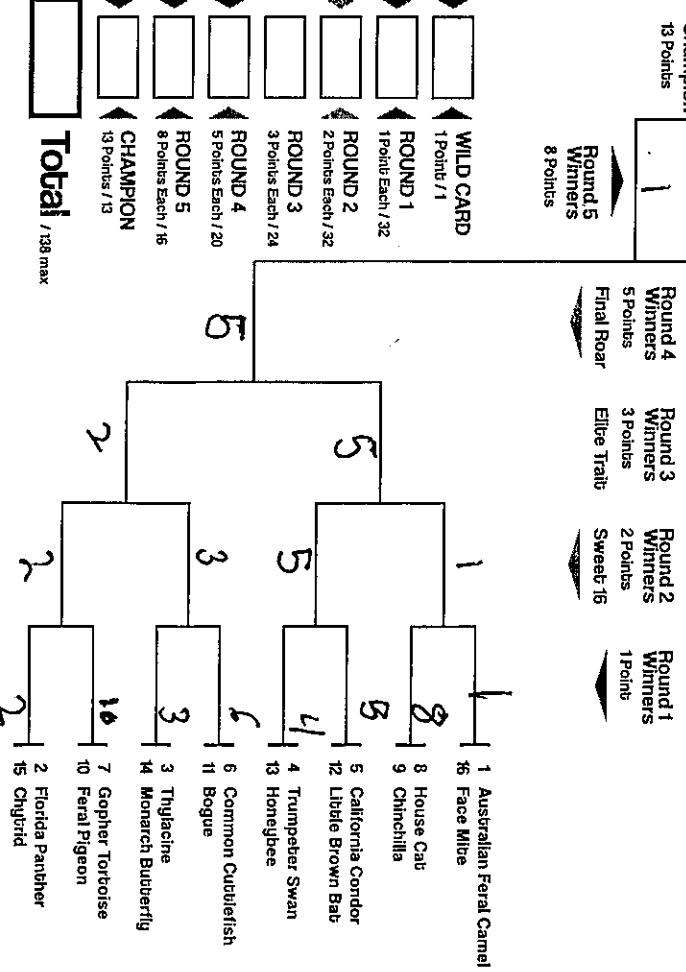
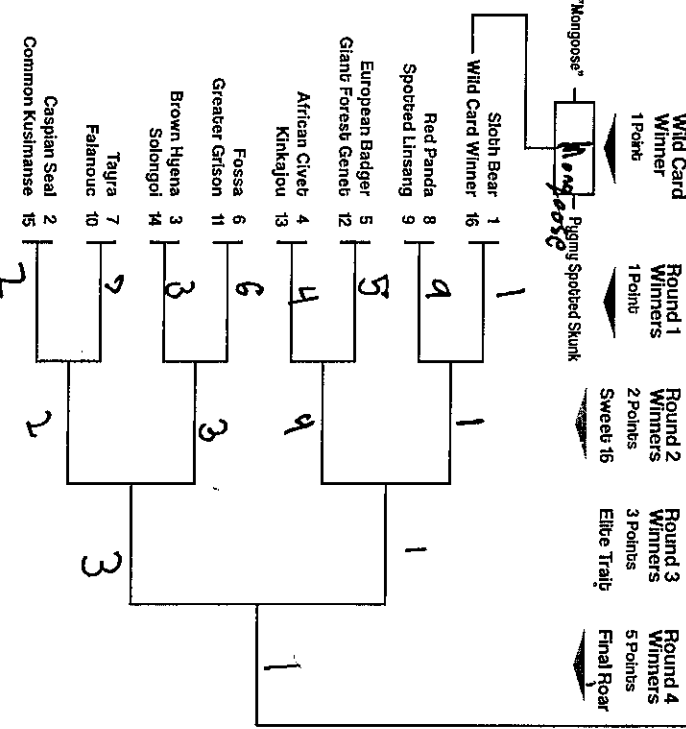

AnthroPOSCENE

Jaelynn Adams

Your Name Goes Here

2020 MARCH

Mammal Madness
mammalstuck.blogspot.com

MMM created and directed by
Prof Katie Hinde, Arizona State University
v.1. Deng Bracket design by Will McElroy

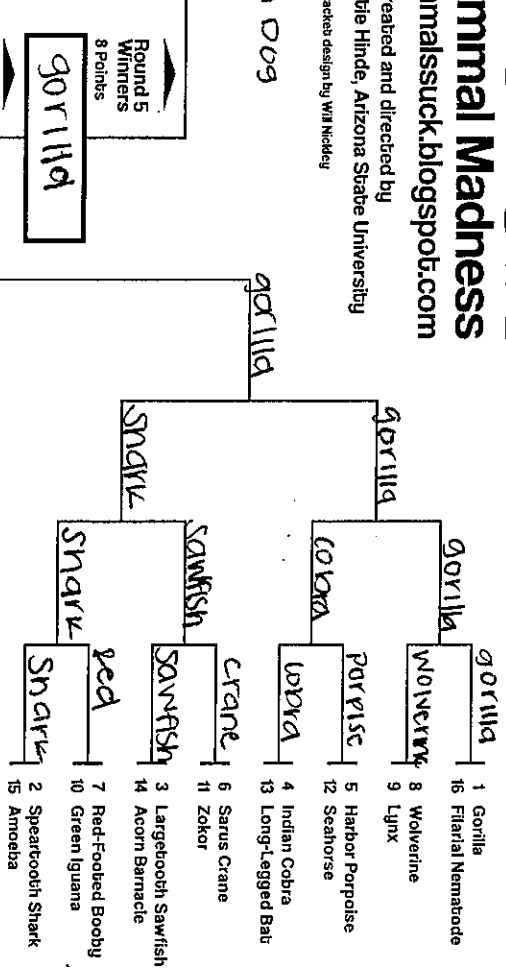
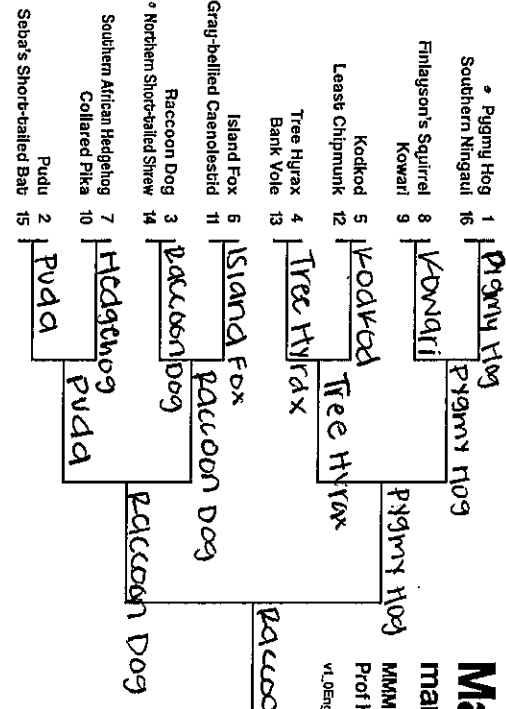

Double Trouble

Cats-ish vs. Dogs-ish

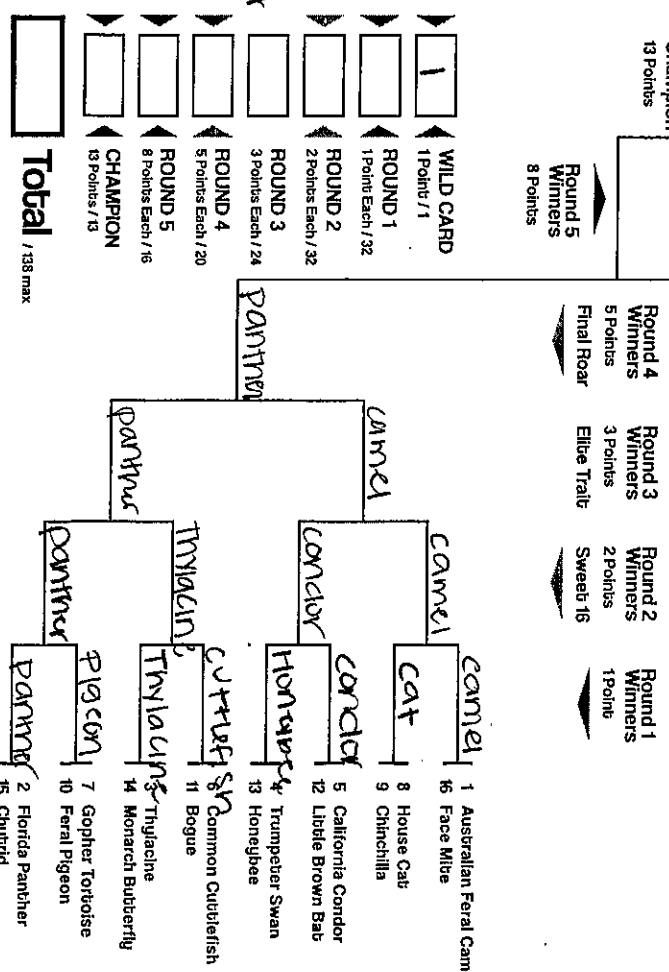
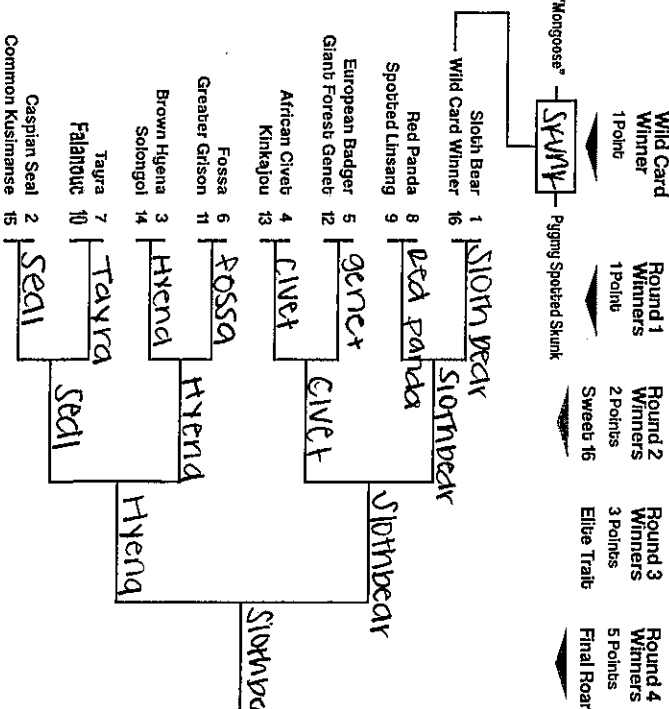

AnthropoSCENE

1	WILD CARD	1 Point / 1
2	ROUND 1	1 Point Each / 32
3	ROUND 2	2 Points Each / 32
4	ROUND 3	3 Points Each / 24
5	ROUND 4	5 Points Each / 20
6	ROUND 5	8 Points Each / 16
7	CHAMPION	13 Points / 13
Total		138 max

Allison Stephens
Your Name Goes Here

Womefield
 advanced
 specific to environment

2020

Mammoth March

Mammal Madness
 mammalssuck.blogspot.com

MMM created and directed by
 Prof Katie Hinde, Arizona State University
v1.0 Eng Bracket design by WINNIDeJ

Tiny Terrors

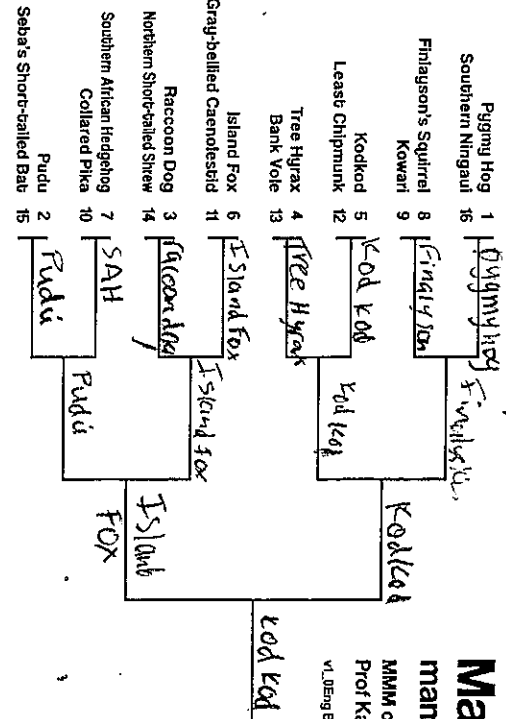

Cats-ish vs. Dogs-ish

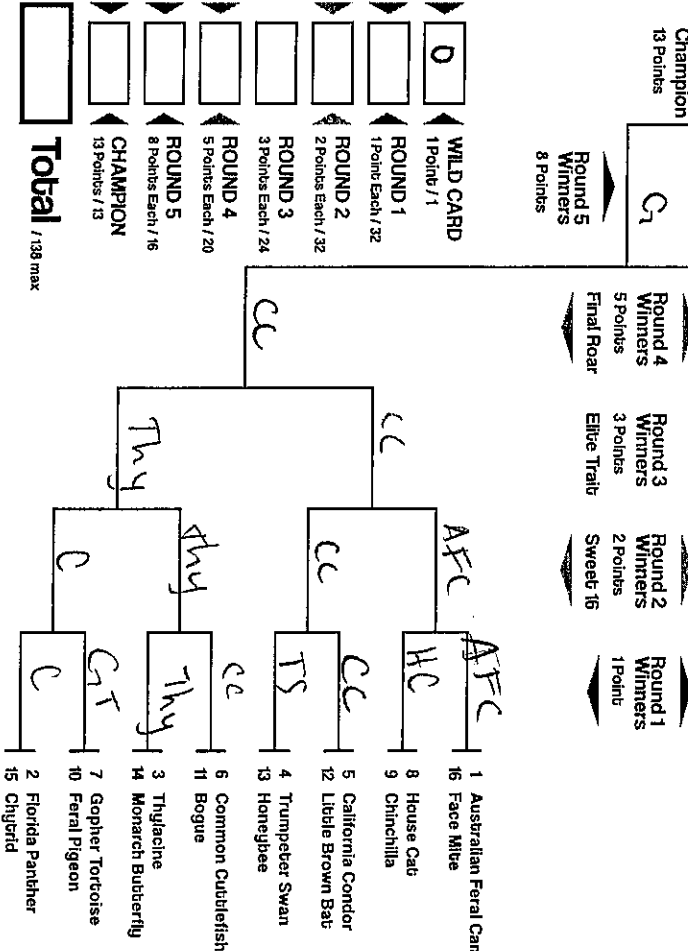
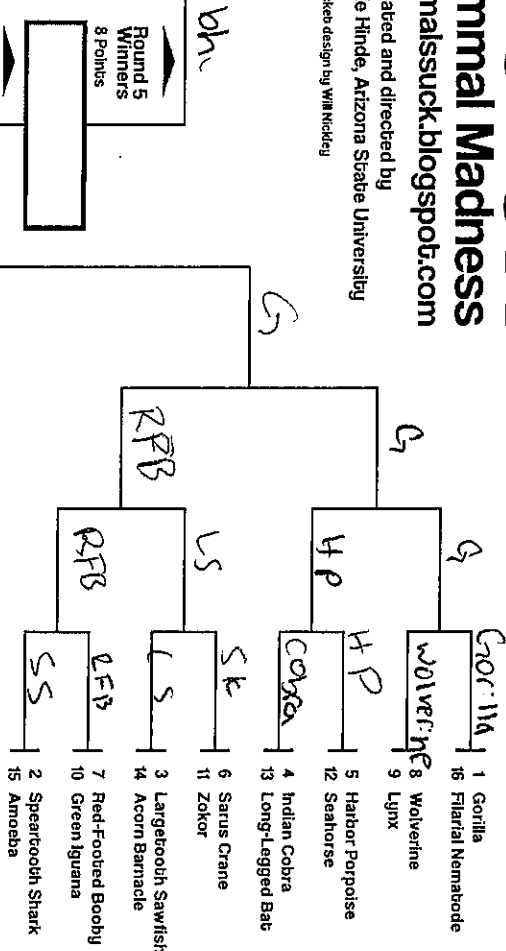
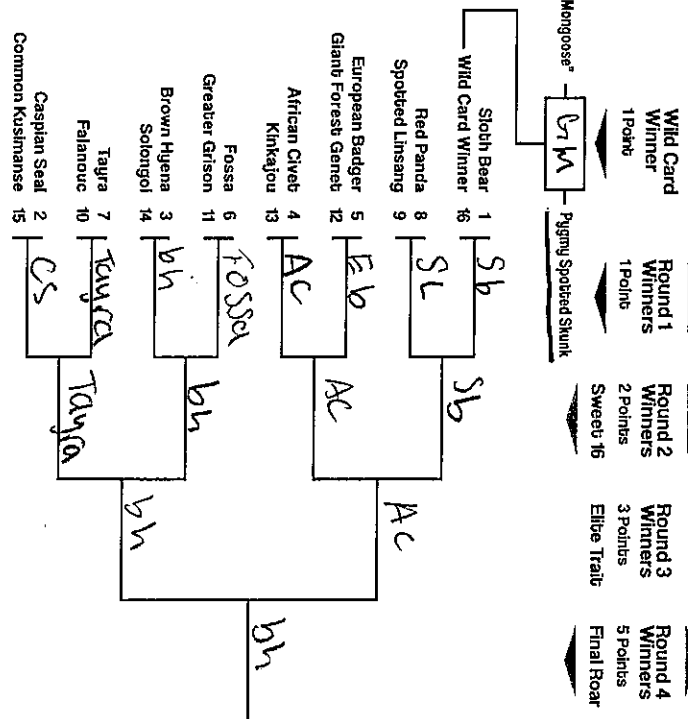

Double Trouble

AnthroPOSCENE

- WILD CARD 1 Point / 1
- ROUND 1 1 Point Each / 32
- ROUND 2 2 Points Each / 32
- ROUND 3 3 Points Each / 24
- ROUND 4 5 Points Each / 20
- ROUND 5 8 Points Each / 16
- CHAMPION 13 Points / 13
- Total / 138 max

Loke Hauser
Your Name Goes Here

2020 Mammal March

Mammal Madness
mammalssuck.blogspot.com

MMM created and directed by Prof Kabile Hinde, Arizona State University
V.L. Ding Bracket design by Will Nickley

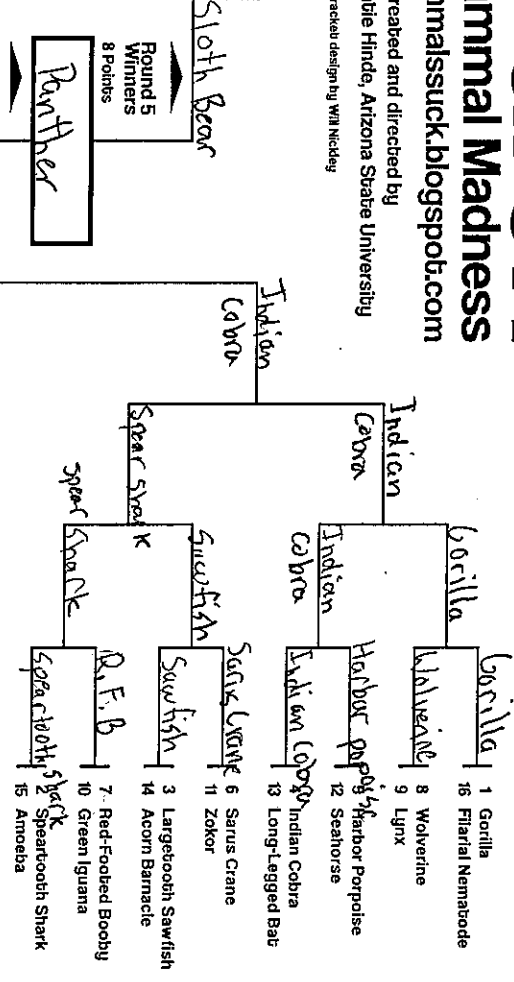
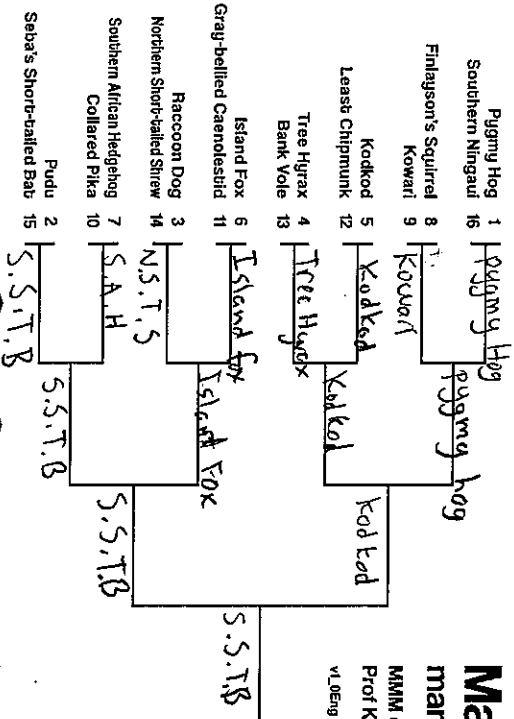

Double Trouble

Cats-ish vs. Dogs-ish

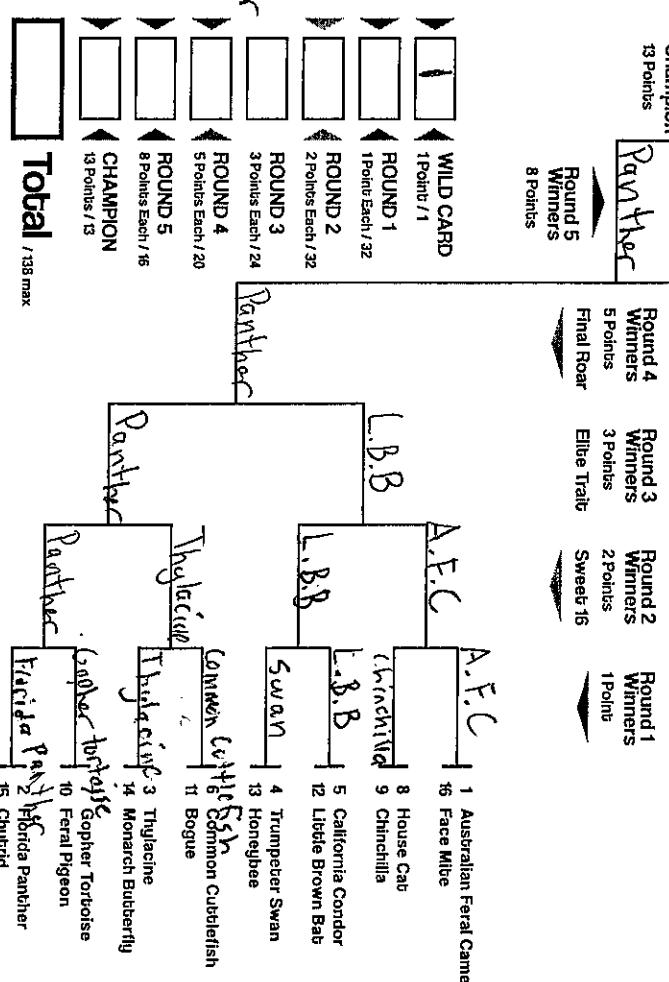
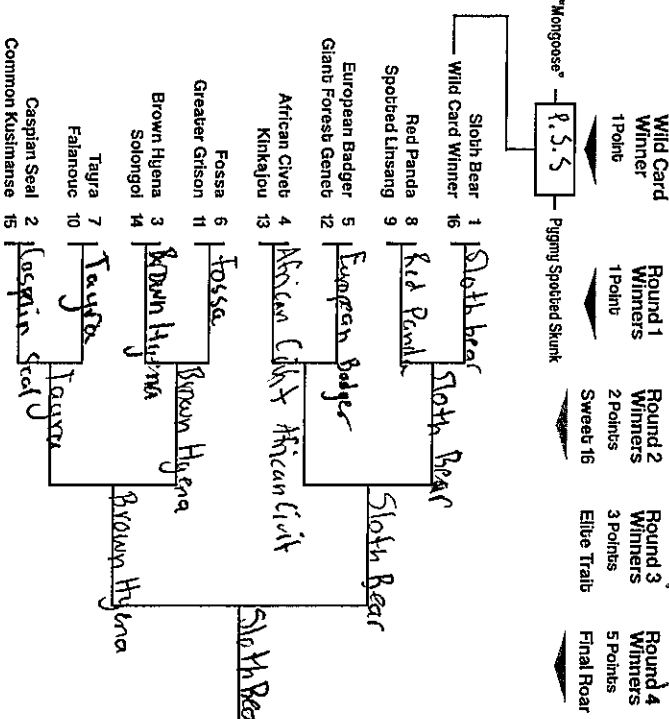

AnthropoSCENE

WILD CARD 1 Point / 1
 ROUND 1 1 Point Each / 32
 ROUND 2 2 Points Each / 32
 ROUND 3 3 Points Each / 24
 ROUND 4 5 Points Each / 20
 ROUND 5 8 Points Each / 16
 CHAMPION 13 Points / 13
 Total / 138 max

Abb: RLVCF

Your Name Goes Here

2020 MARCH

Mammal Madness

mammalsuck.blogspot.com

MMM created and directed by Prof Kabie Hinde, Arizona State University

*Long Bracket design by Will Nickley

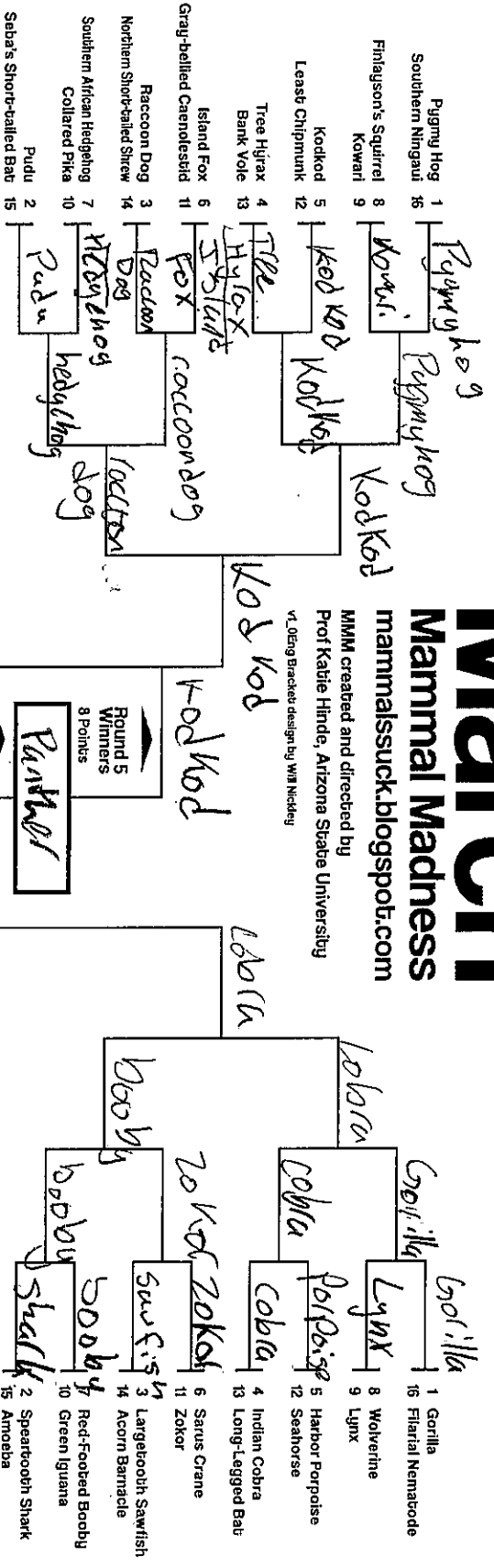

Double Trouble

Cats-ish vs. Dogs-ish

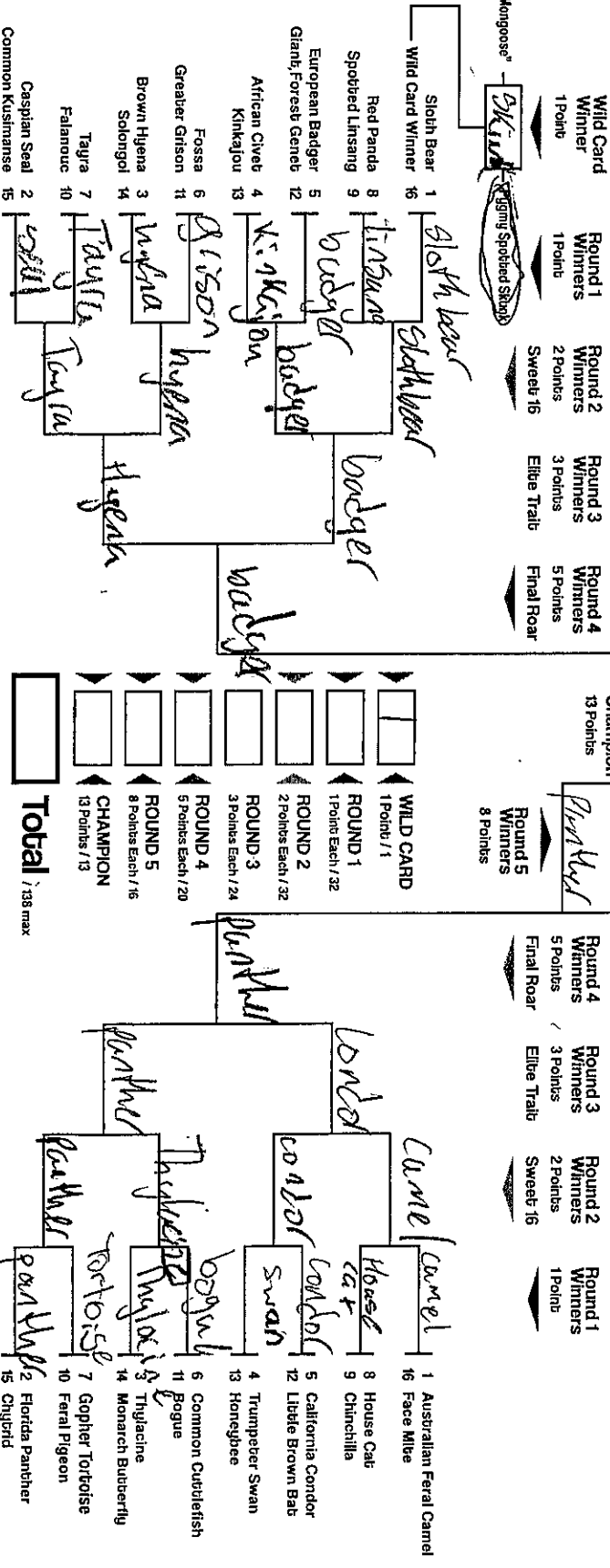

AnthropoSCENE

WILD CARD	1 Point / 1
ROUND 1	1 Point Each / 32
ROUND 2	2 Points Each / 32
ROUND 3	3 Points Each / 24
ROUND 4	5 Points Each / 20
ROUND 5	8 Points Each / 16
CHAMPION	13 Points / 13
Total	138 max

- 1 Gorilla
- 2 Spine-tailed Hornbill
- 3 Large-toothed Sawfish
- 4 Acorn Barnacle
- 5 Red-footed Booby
- 6 Green Iguana
- 7 Speartooth Shark
- 8 Aardvark
- 9 Armadillo
- 10 American Badger
- 11 American Bittern
- 12 American Coot
- 13 American Crow
- 14 American Goldfinch
- 15 American Robin
- 16 American Woodcock
- 17 Australian Feral Camel
- 18 Face Mite
- 19 House Cat
- 20 Chinchilla
- 21 California Condor
- 22 Little Brown Bat
- 23 Trumpeter Swan
- 24 Honigsee
- 25 Common Cuttlefish
- 26 Bogue
- 27 Thylacine
- 28 Monarch Butterfly
- 29 Gopher Tortoise
- 30 Feral Pigeon
- 31 Florida Panther
- 32 Chytrid

Kevin Choque
Your Name Goes Here

2020 Mammal March

mammalstuck.blogspot.com

MMM created and directed by Prof Katie Hinde, Arizona State University
V1.0 Ding Bracket design by Will Nickey

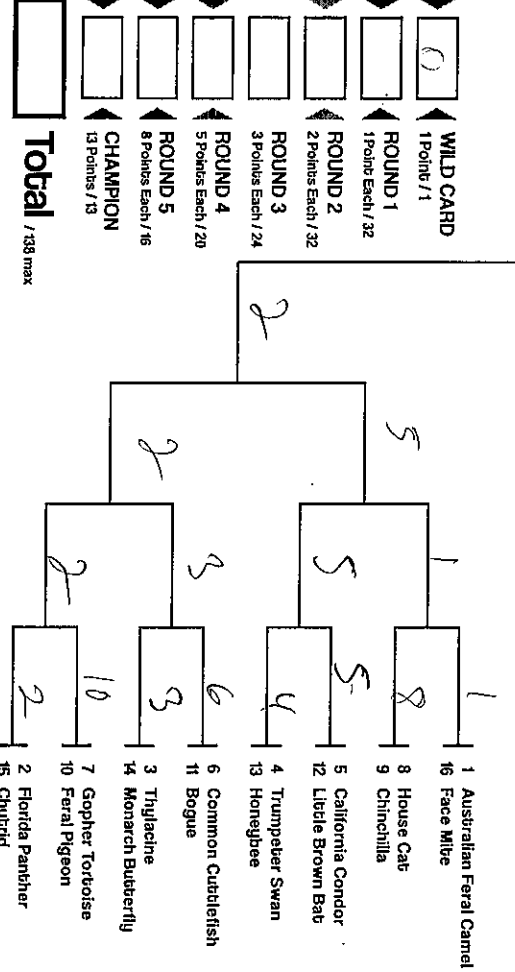
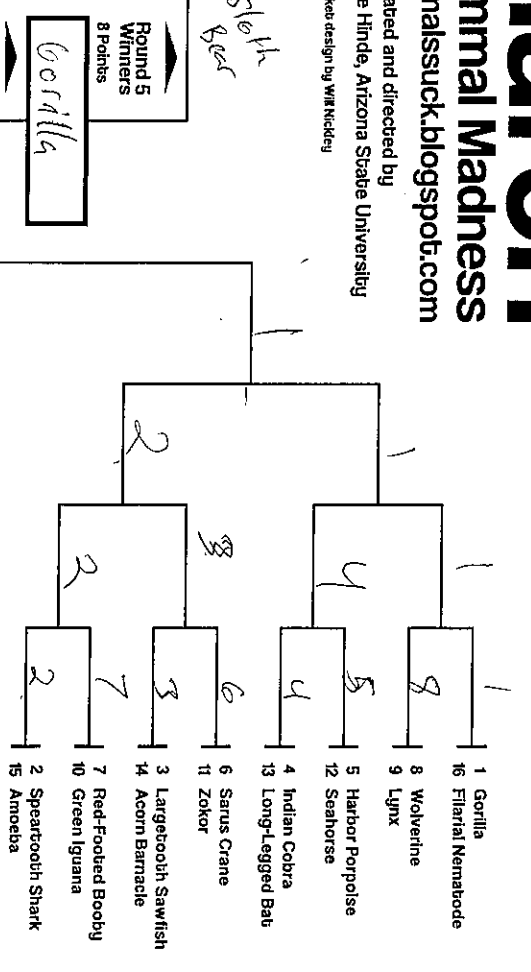
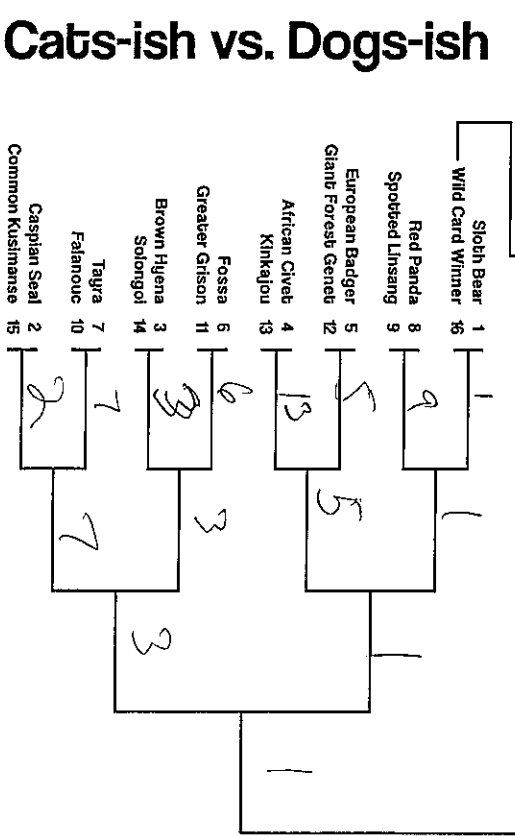
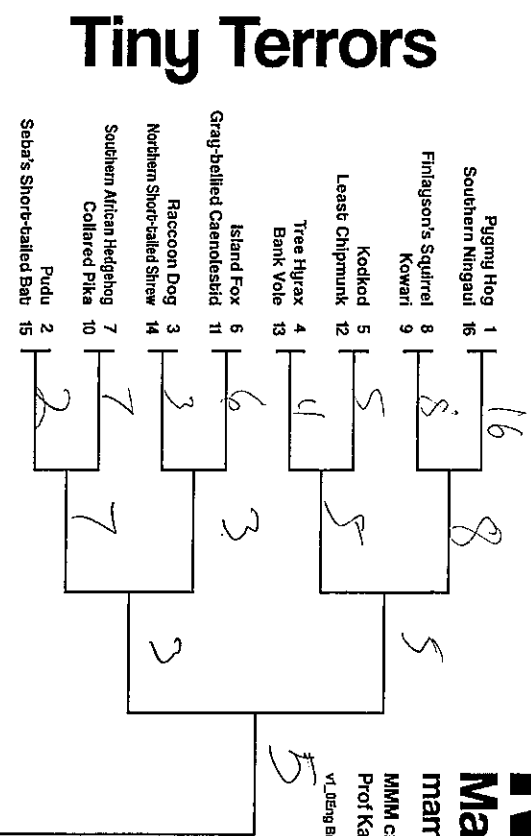

Champion 13 Points

Round 5 Winners 8 Points

Round 5 Winners 8 Points

WILD CARD 1 Point / 1

ROUND 1 1 Point Each / 32

ROUND 2 2 Points Each / 32

ROUND 3 3 Points Each / 24

ROUND 4 5 Points Each / 20

ROUND 5 8 Points Each / 16

CHAMPION 13 Points / 13

Total / 138 max

cinza B. Baker
Your Name Goes Here

2020 Mammal March

Mammal Madness
mammalssuck.blogspot.com

MMM created and directed by
Prof. Katie Hinde, Arizona State University
v.1.0 Eng Bracket design by Will Nickley

Tiny Terrors

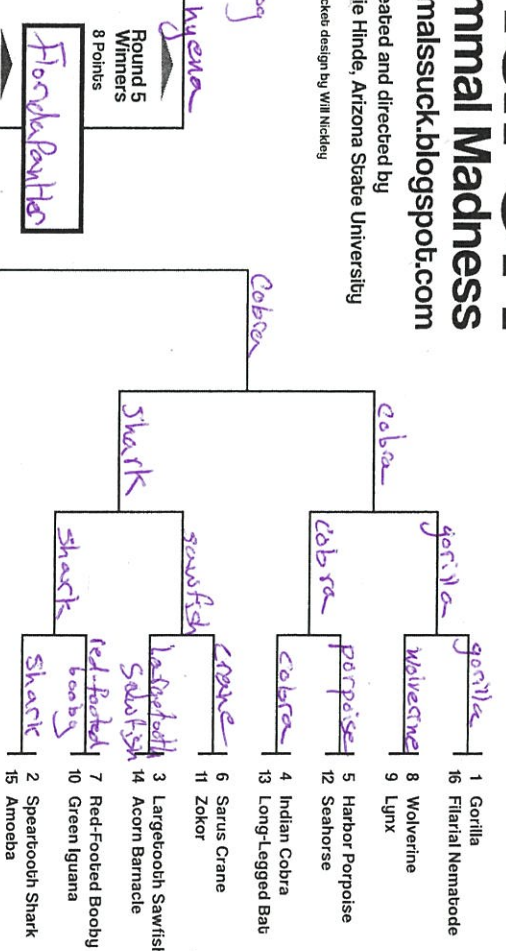
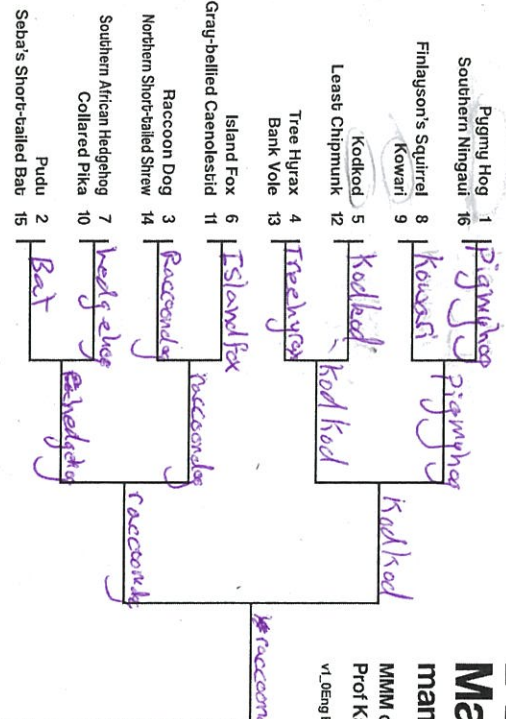

Double Trouble

Cats-ish vs. Dogs-ish

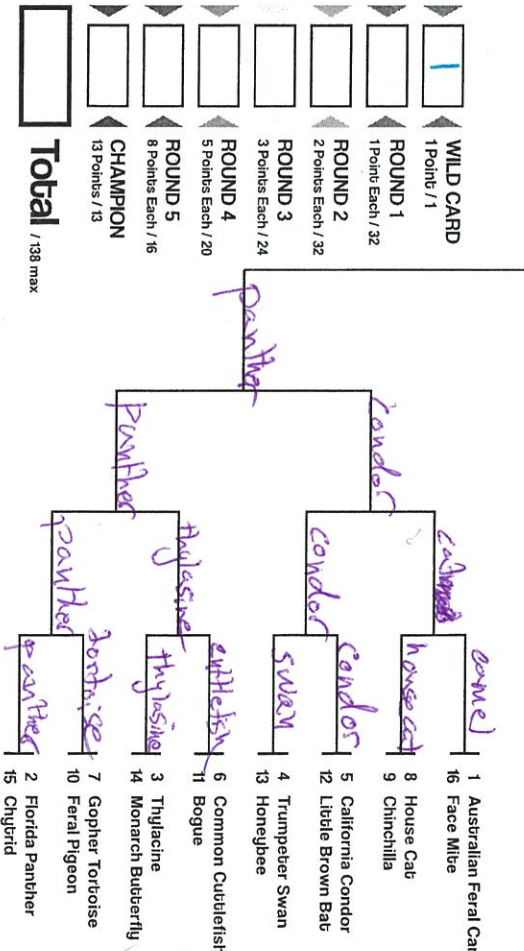
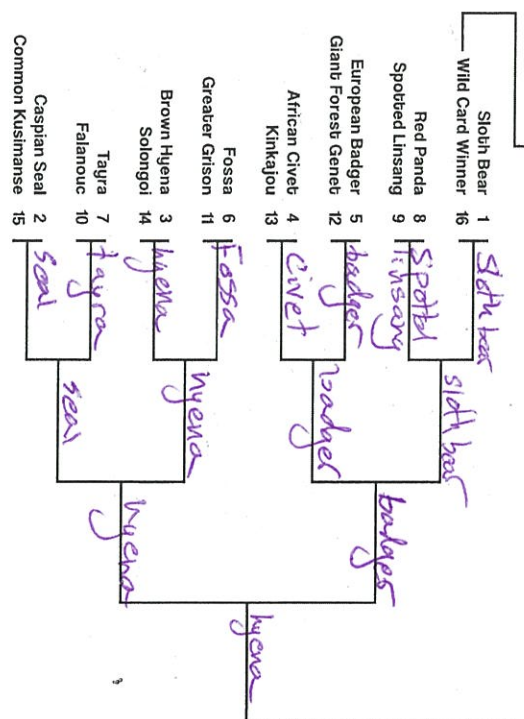

AnthroSCENE

1	WILD CARD	1 Point / 1
2	ROUND 1	1 Point Each / 32
3	ROUND 2	2 Points Each / 32
4	ROUND 3	3 Points Each / 24
5	ROUND 4	5 Points Each / 20
6	ROUND 5	8 Points Each / 16
7	CHAMPION	13 Points / 13
8	Total	138 max

00

Jacobs-Stromger

Your Name Goes Here

2020

Mammal March

Mammal Madness

mammalssuck.blogspot.com

MM created and directed by Prof Katie Hinde, Arizona State University
V. Deng Bracket design by Will Middleij

Tiny Terrors

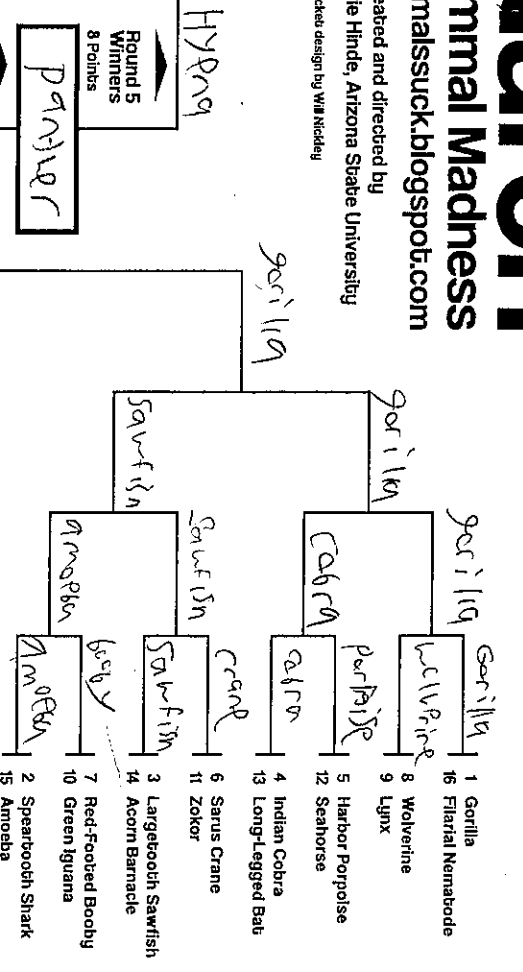
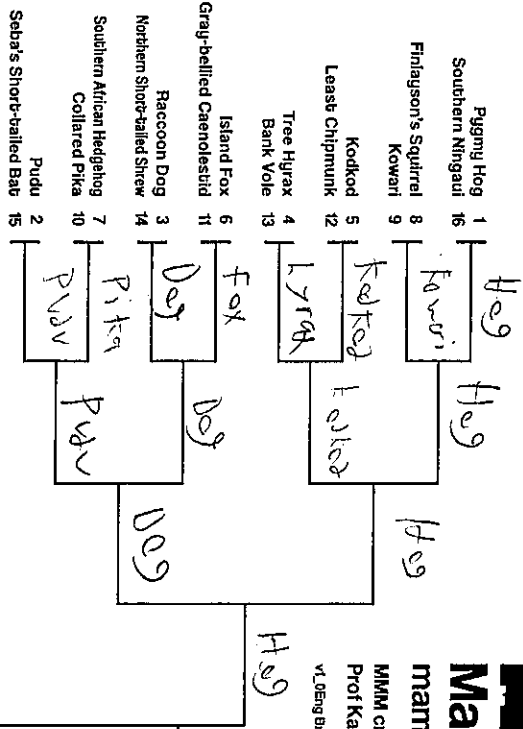

Cats-ish vs. Dogs-ish

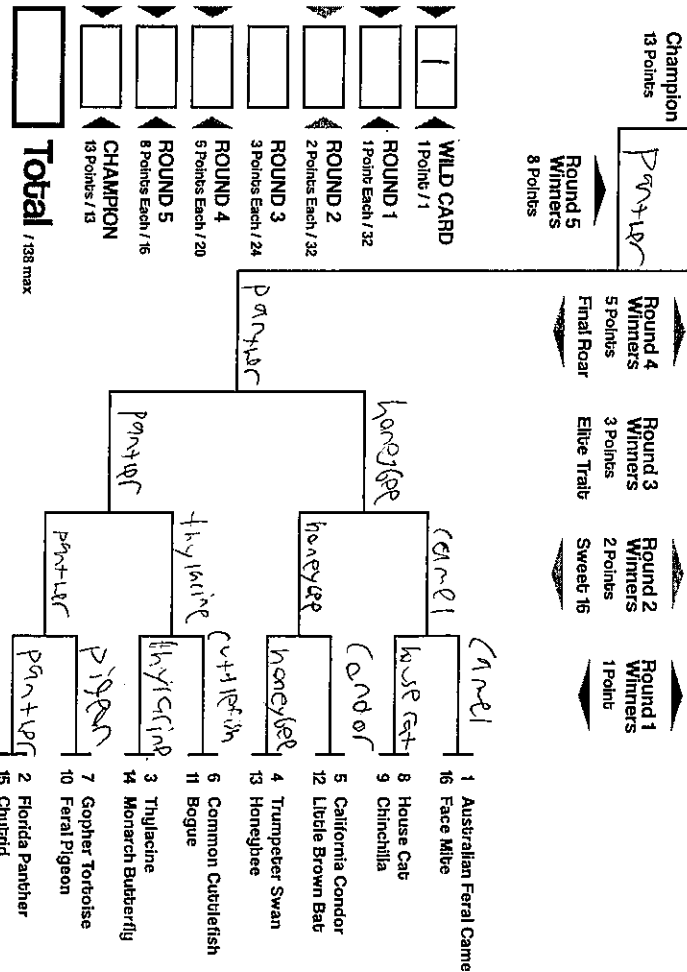
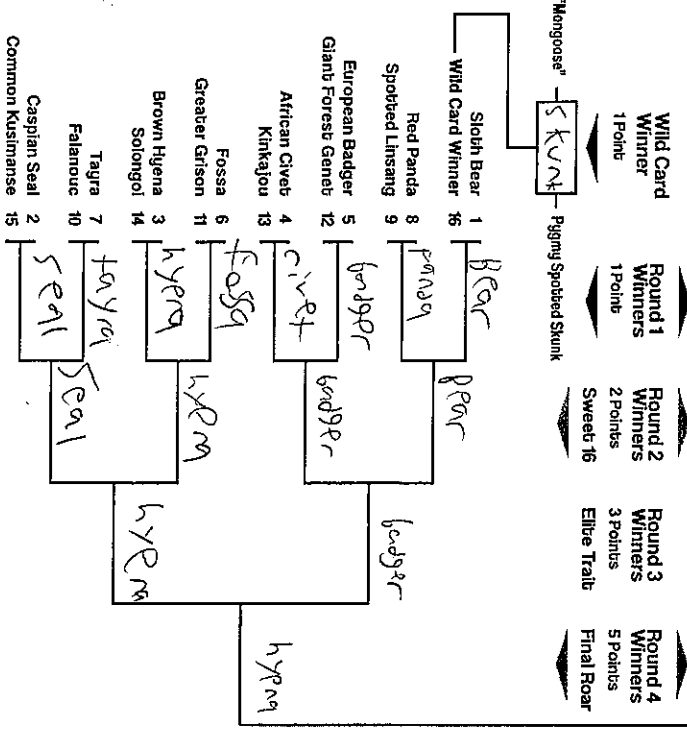

AnthroSCENE

Double Trouble

WILD CARD
1 Point / 1
ROUND 1
1 Point Each / 32
ROUND 2
2 Points Each / 32
ROUND 3
3 Points Each / 24
ROUND 4
5 Points Each / 20
ROUND 5
8 Points Each / 16
CHAMPION
13 Points / 13
Total / 138 max

Regan McBride
Your Name Goes Here

2020

Mammoth March

Mammal Madness
mammalssuck.blogspot.com
MMM created and directed by
Prof Katie Hinde, Arizona State University
v. Log Bracket design by Will Nickley

Tiny Terrors

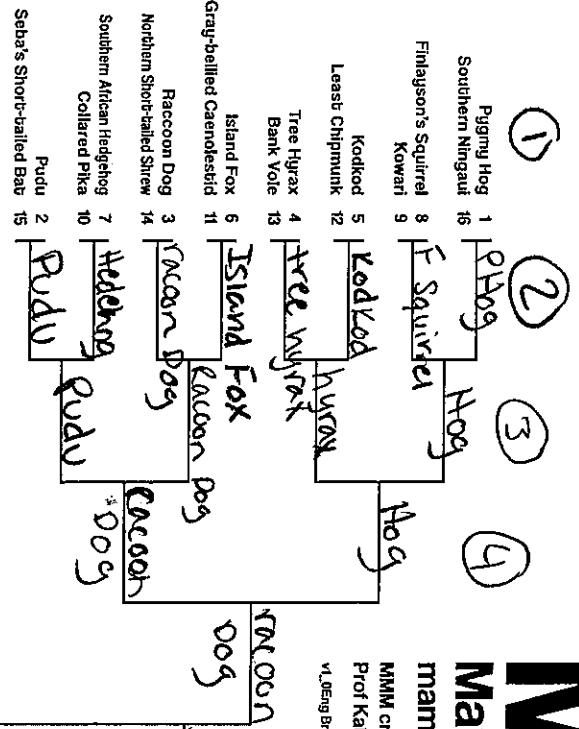

Cats-ish vs. Dogs-ish

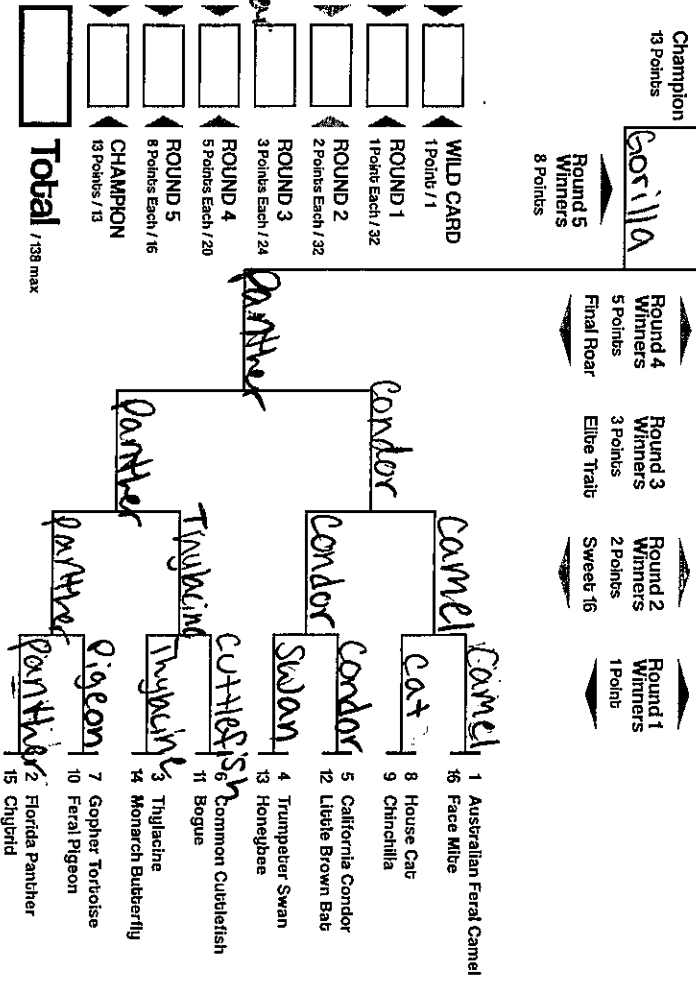
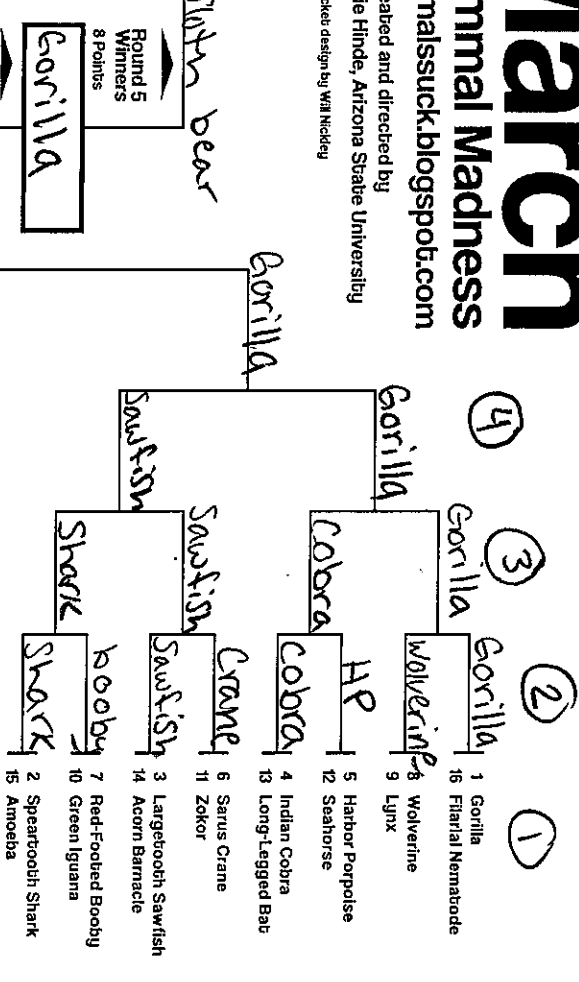
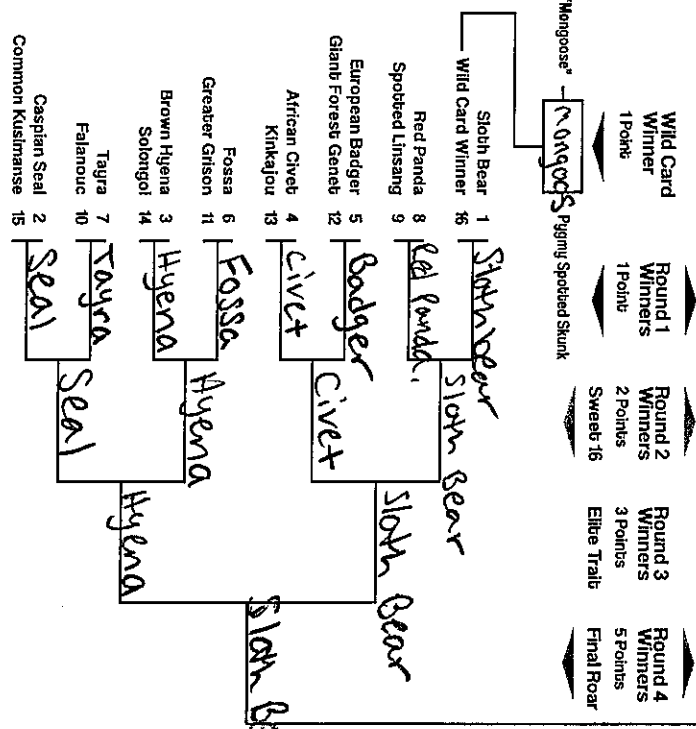

Double Trouble

AnthropoSCENE

- 1 Gorilla
- 16 Flarial Nematode
- 1 Lynx
- 5 Harbor Porpoise
- 12 Sealorse
- 4 Indian Cobra
- 13 Long-Legged Bat
- 6 Sarus Crane
- 11 Zokor
- 3 Large-tooth Sawfish
- 14 Acorn Barnacle
- 7 Red-footed Booby
- 10 Green Iguana
- 2 Spear-tooth Shark
- 15 Amoeba

- 1 Australian Feral Camel
- 16 Face Mite
- 8 House Cat
- 9 Chinchilla
- 5 California Condor
- 12 Little Brown Bat
- 4 Trumpeter Swan
- 13 Honeybee
- 6 Common Cuttlefish
- 11 Bogue
- 14 Monarch Butterfly
- 7 Gopher Tortoise
- 10 Feral Pigeon
- 15 Citybird

Regan Best

Your Name Goes Here

1. Look (physical)
2. Habitat

2020 Mammal March

Mammal Madness
mammalssuck.blogspot.com

MM created and directed by
Prof Kabie Hinde, Arizona State University
V. Deng Bracket design by Will Nickley

Tiny Terrors

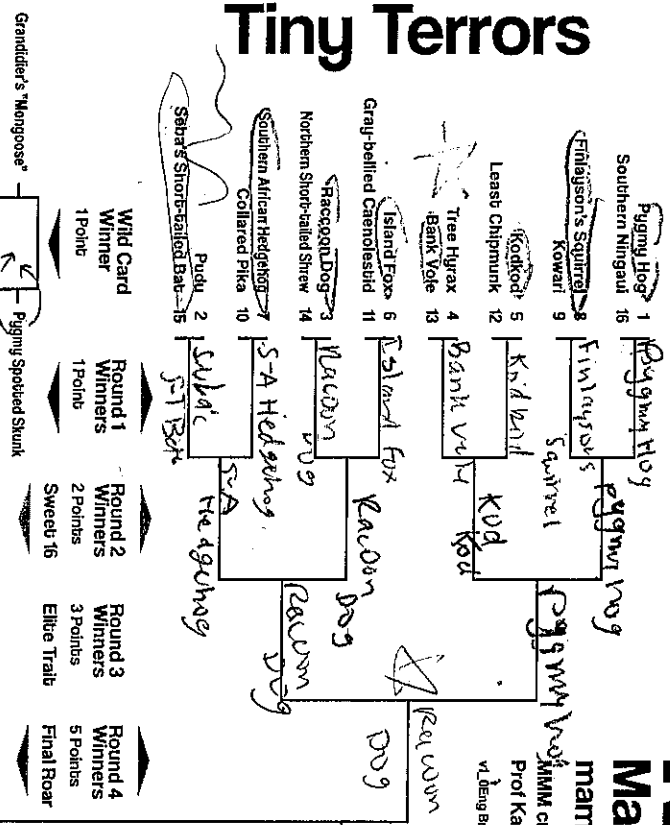

Round 5 Winners 8 Points
Gorilla

Round 5 Winners 8 Points
Gorilla

Champion 13 Points
Gorilla

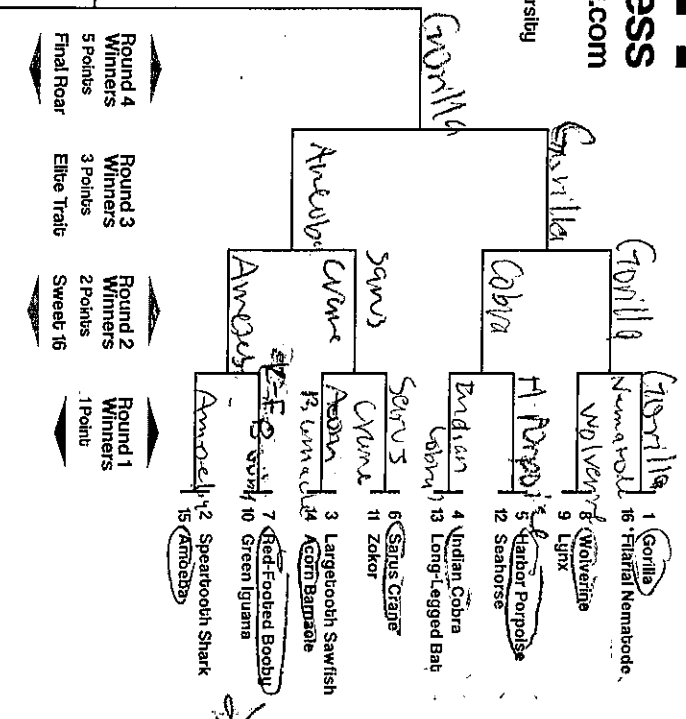

AnthropoSCENE

Cats-ish vs. Dogs-ish

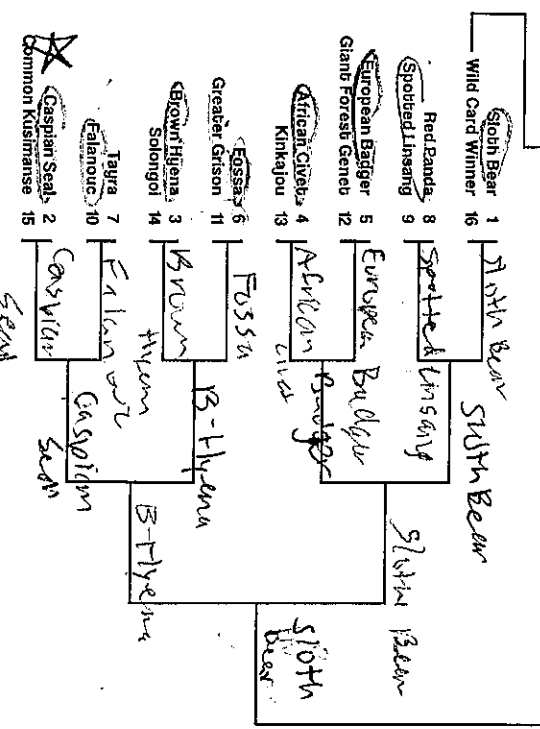

Round 5 Winners 8 Points
WILD CARD

Round 5 Winners 8 Points
WILD CARD

Champion 13 Points
WILD CARD

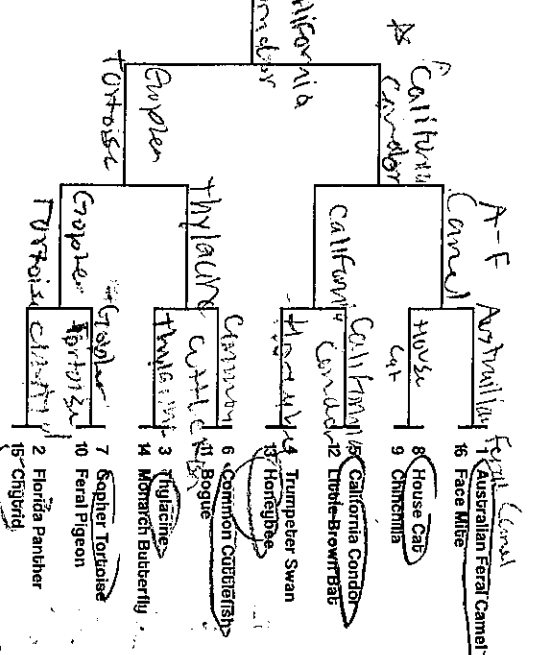

Double Trouble

Hayouk Adhikan
Your Name Goes Here

2020

March

Mammal Madness

mammalssuck.blogspot.com

MMM created and directed by Prof Katie Hinde, Arizona State University
v1.0.org Bracket design by Will Nickley

Tiny Terrors

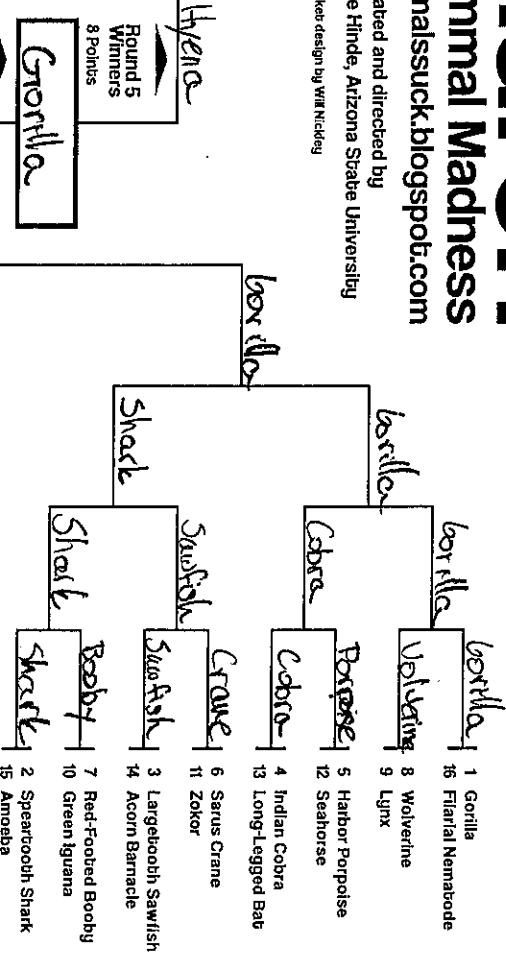
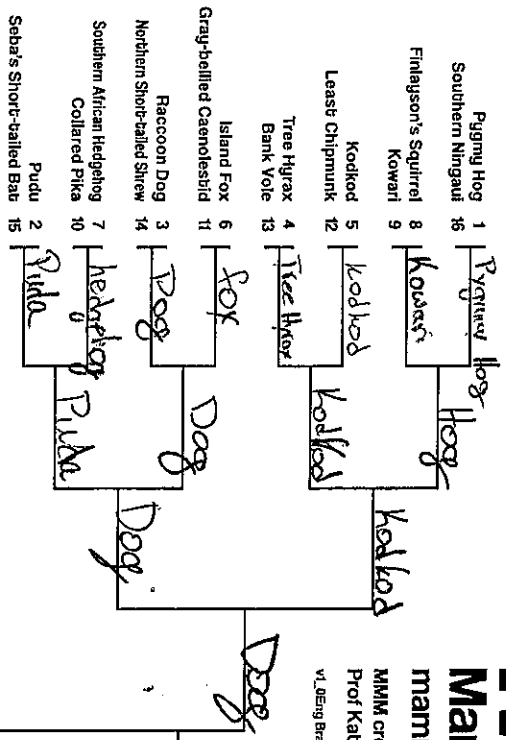

Cats-ish vs. Dogs-ish

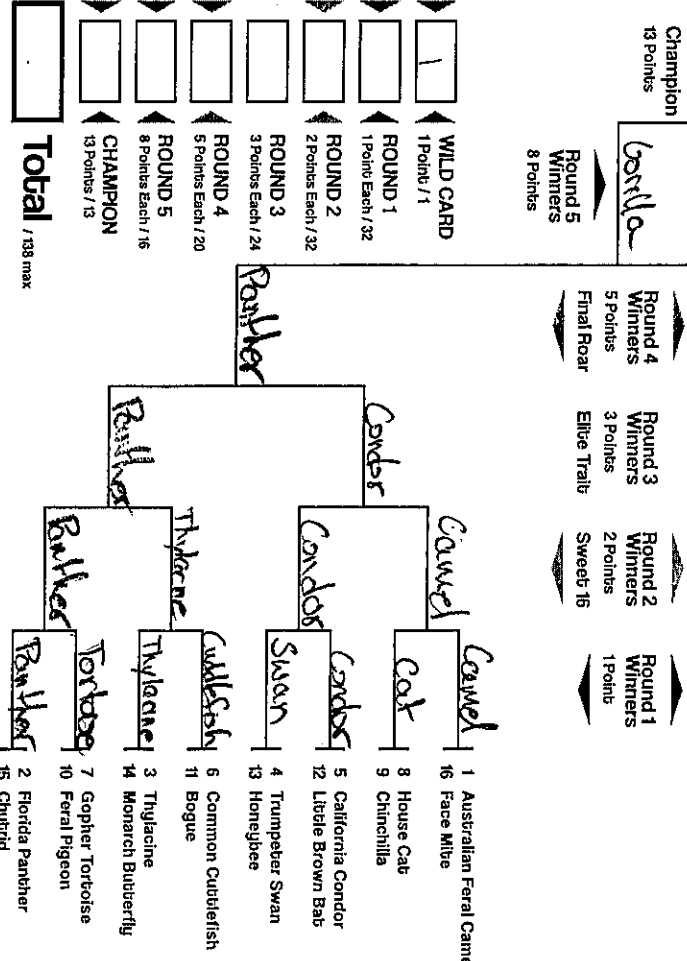
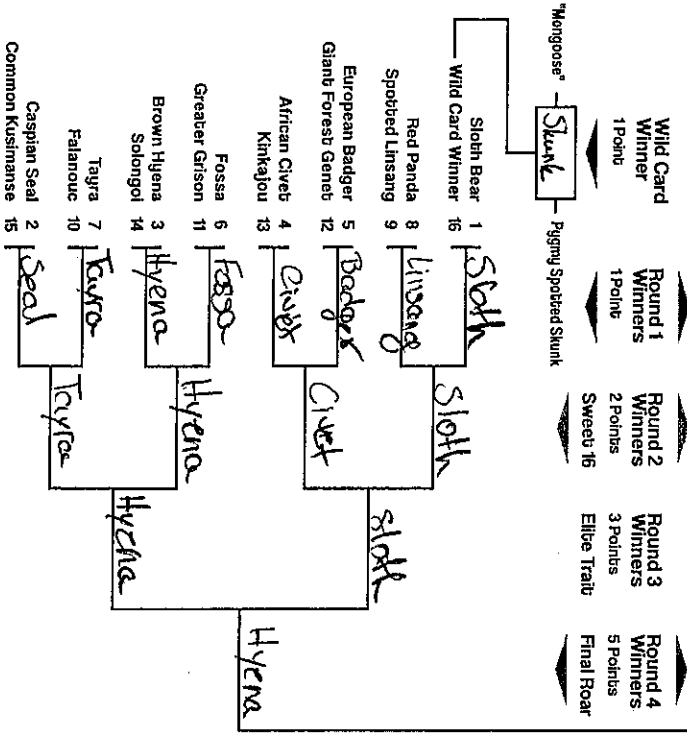

Double Trouble

AnthroSCENE

- 1 Pygmy Hog
- 2 Pudú
- 3 Raccoon Dog
- 4 Tree Hyrax
- 5 Least Chipmunk
- 6 Island Fox
- 7 Southern African Hedgehog
- 8 Kowari
- 9 Kowari
- 10 Collared Pike
- 11 Gray-bellied Caenolestid
- 12 Kookaburra
- 13 Bank Vole
- 14 Raccoon Dog
- 15 Sebat's Short-tailed Bat
- 16 Wild Card Winner
- 17 Raccoon Dog
- 18 Tree Hyrax
- 19 Least Chipmunk
- 20 Island Fox
- 21 Southern African Hedgehog
- 22 Kowari
- 23 Kowari
- 24 Collared Pike
- 25 Gray-bellied Caenolestid
- 26 Kookaburra
- 27 Bank Vole
- 28 Raccoon Dog
- 29 Sebat's Short-tailed Bat
- 30 Wild Card Winner
- 31 Raccoon Dog
- 32 Tree Hyrax
- 33 Least Chipmunk
- 34 Island Fox
- 35 Southern African Hedgehog
- 36 Kowari
- 37 Kowari
- 38 Collared Pike
- 39 Gray-bellied Caenolestid
- 40 Kookaburra
- 41 Bank Vole
- 42 Raccoon Dog
- 43 Sebat's Short-tailed Bat
- 44 Wild Card Winner
- 45 Raccoon Dog
- 46 Tree Hyrax
- 47 Least Chipmunk
- 48 Island Fox
- 49 Southern African Hedgehog
- 50 Kowari
- 51 Kowari
- 52 Collared Pike
- 53 Gray-bellied Caenolestid
- 54 Kookaburra
- 55 Bank Vole
- 56 Raccoon Dog
- 57 Sebat's Short-tailed Bat
- 58 Wild Card Winner
- 59 Raccoon Dog
- 60 Tree Hyrax
- 61 Least Chipmunk
- 62 Island Fox
- 63 Southern African Hedgehog
- 64 Kowari
- 65 Kowari
- 66 Collared Pike
- 67 Gray-bellied Caenolestid
- 68 Kookaburra
- 69 Bank Vole
- 70 Raccoon Dog
- 71 Sebat's Short-tailed Bat
- 72 Wild Card Winner
- 73 Raccoon Dog
- 74 Tree Hyrax
- 75 Least Chipmunk
- 76 Island Fox
- 77 Southern African Hedgehog
- 78 Kowari
- 79 Kowari
- 80 Collared Pike
- 81 Gray-bellied Caenolestid
- 82 Kookaburra
- 83 Bank Vole
- 84 Raccoon Dog
- 85 Sebat's Short-tailed Bat
- 86 Wild Card Winner
- 87 Raccoon Dog
- 88 Tree Hyrax
- 89 Least Chipmunk
- 90 Island Fox
- 91 Southern African Hedgehog
- 92 Kowari
- 93 Kowari
- 94 Collared Pike
- 95 Gray-bellied Caenolestid
- 96 Kookaburra
- 97 Bank Vole
- 98 Raccoon Dog
- 99 Sebat's Short-tailed Bat
- 100 Wild Card Winner
- 101 Raccoon Dog
- 102 Tree Hyrax
- 103 Least Chipmunk
- 104 Island Fox
- 105 Southern African Hedgehog
- 106 Kowari
- 107 Kowari
- 108 Collared Pike
- 109 Gray-bellied Caenolestid
- 110 Kookaburra
- 111 Bank Vole
- 112 Raccoon Dog
- 113 Sebat's Short-tailed Bat
- 114 Wild Card Winner
- 115 Raccoon Dog
- 116 Tree Hyrax
- 117 Least Chipmunk
- 118 Island Fox
- 119 Southern African Hedgehog
- 120 Kowari
- 121 Kowari
- 122 Collared Pike
- 123 Gray-bellied Caenolestid
- 124 Kookaburra
- 125 Bank Vole
- 126 Raccoon Dog
- 127 Sebat's Short-tailed Bat
- 128 Wild Card Winner
- 129 Raccoon Dog
- 130 Tree Hyrax
- 131 Least Chipmunk
- 132 Island Fox
- 133 Southern African Hedgehog
- 134 Kowari
- 135 Kowari
- 136 Collared Pike
- 137 Gray-bellied Caenolestid
- 138 Kookaburra
- 139 Bank Vole
- 140 Raccoon Dog
- 141 Sebat's Short-tailed Bat
- 142 Wild Card Winner
- 143 Raccoon Dog
- 144 Tree Hyrax
- 145 Least Chipmunk
- 146 Island Fox
- 147 Southern African Hedgehog
- 148 Kowari
- 149 Kowari
- 150 Collared Pike
- 151 Gray-bellied Caenolestid
- 152 Kookaburra
- 153 Bank Vole
- 154 Raccoon Dog
- 155 Sebat's Short-tailed Bat
- 156 Wild Card Winner
- 157 Raccoon Dog
- 158 Tree Hyrax
- 159 Least Chipmunk
- 160 Island Fox
- 161 Southern African Hedgehog
- 162 Kowari
- 163 Kowari
- 164 Collared Pike
- 165 Gray-bellied Caenolestid
- 166 Kookaburra
- 167 Bank Vole
- 168 Raccoon Dog
- 169 Sebat's Short-tailed Bat
- 170 Wild Card Winner
- 171 Raccoon Dog
- 172 Tree Hyrax
- 173 Least Chipmunk
- 174 Island Fox
- 175 Southern African Hedgehog
- 176 Kowari
- 177 Kowari
- 178 Collared Pike
- 179 Gray-bellied Caenolestid
- 180 Kookaburra
- 181 Bank Vole
- 182 Raccoon Dog
- 183 Sebat's Short-tailed Bat
- 184 Wild Card Winner
- 185 Raccoon Dog
- 186 Tree Hyrax
- 187 Least Chipmunk
- 188 Island Fox
- 189 Southern African Hedgehog
- 190 Kowari
- 191 Kowari
- 192 Collared Pike
- 193 Gray-bellied Caenolestid
- 194 Kookaburra
- 195 Bank Vole
- 196 Raccoon Dog
- 197 Sebat's Short-tailed Bat
- 198 Wild Card Winner
- 199 Raccoon Dog
- 200 Tree Hyrax
- 201 Least Chipmunk
- 202 Island Fox
- 203 Southern African Hedgehog
- 204 Kowari
- 205 Kowari
- 206 Collared Pike
- 207 Gray-bellied Caenolestid
- 208 Kookaburra
- 209 Bank Vole
- 210 Raccoon Dog
- 211 Sebat's Short-tailed Bat
- 212 Wild Card Winner
- 213 Raccoon Dog
- 214 Tree Hyrax
- 215 Least Chipmunk
- 216 Island Fox
- 217 Southern African Hedgehog
- 218 Kowari
- 219 Kowari
- 220 Collared Pike
- 221 Gray-bellied Caenolestid
- 222 Kookaburra
- 223 Bank Vole
- 224 Raccoon Dog
- 225 Sebat's Short-tailed Bat
- 226 Wild Card Winner
- 227 Raccoon Dog
- 228 Tree Hyrax
- 229 Least Chipmunk
- 230 Island Fox
- 231 Southern African Hedgehog
- 232 Kowari
- 233 Kowari
- 234 Collared Pike
- 235 Gray-bellied Caenolestid
- 236 Kookaburra
- 237 Bank Vole
- 238 Raccoon Dog
- 239 Sebat's Short-tailed Bat
- 240 Wild Card Winner
- 241 Raccoon Dog
- 242 Tree Hyrax
- 243 Least Chipmunk
- 244 Island Fox
- 245 Southern African Hedgehog
- 246 Kowari
- 247 Kowari
- 248 Collared Pike
- 249 Gray-bellied Caenolestid
- 250 Kookaburra
- 251 Bank Vole
- 252 Raccoon Dog
- 253 Sebat's Short-tailed Bat
- 254 Wild Card Winner
- 255 Raccoon Dog
- 256 Tree Hyrax
- 257 Least Chipmunk
- 258 Island Fox
- 259 Southern African Hedgehog
- 260 Kowari
- 261 Kowari
- 262 Collared Pike
- 263 Gray-bellied Caenolestid
- 264 Kookaburra
- 265 Bank Vole
- 266 Raccoon Dog
- 267 Sebat's Short-tailed Bat
- 268 Wild Card Winner
- 269 Raccoon Dog
- 270 Tree Hyrax
- 271 Least Chipmunk
- 272 Island Fox
- 273 Southern African Hedgehog
- 274 Kowari
- 275 Kowari
- 276 Collared Pike
- 277 Gray-bellied Caenolestid
- 278 Kookaburra
- 279 Bank Vole
- 280 Raccoon Dog
- 281 Sebat's Short-tailed Bat
- 282 Wild Card Winner
- 283 Raccoon Dog
- 284 Tree Hyrax
- 285 Least Chipmunk
- 286 Island Fox
- 287 Southern African Hedgehog
- 288 Kowari
- 289 Kowari
- 290 Collared Pike
- 291 Gray-bellied Caenolestid
- 292 Kookaburra
- 293 Bank Vole
- 294 Raccoon Dog
- 295 Sebat's Short-tailed Bat
- 296 Wild Card Winner
- 297 Raccoon Dog
- 298 Tree Hyrax
- 299 Least Chipmunk
- 300 Island Fox
- 301 Southern African Hedgehog
- 302 Kowari
- 303 Kowari
- 304 Collared Pike
- 305 Gray-bellied Caenolestid
- 306 Kookaburra
- 307 Bank Vole
- 308 Raccoon Dog
- 309 Sebat's Short-tailed Bat
- 310 Wild Card Winner
- 311 Raccoon Dog
- 312 Tree Hyrax
- 313 Least Chipmunk
- 314 Island Fox
- 315 Southern African Hedgehog
- 316 Kowari
- 317 Kowari
- 318 Collared Pike
- 319 Gray-bellied Caenolestid
- 320 Kookaburra
- 321 Bank Vole
- 322 Raccoon Dog
- 323 Sebat's Short-tailed Bat
- 324 Wild Card Winner
- 325 Raccoon Dog
- 326 Tree Hyrax
- 327 Least Chipmunk
- 328 Island Fox
- 329 Southern African Hedgehog
- 330 Kowari
- 331 Kowari
- 332 Collared Pike
- 333 Gray-bellied Caenolestid
- 334 Kookaburra
- 335 Bank Vole
- 336 Raccoon Dog
- 337 Sebat's Short-tailed Bat
- 338 Wild Card Winner
- 339 Raccoon Dog
- 340 Tree Hyrax
- 341 Least Chipmunk
- 342 Island Fox
- 343 Southern African Hedgehog
- 344 Kowari
- 345 Kowari
- 346 Collared Pike
- 347 Gray-bellied Caenolestid
- 348 Kookaburra
- 349 Bank Vole
- 350 Raccoon Dog
- 351 Sebat's Short-tailed Bat
- 352 Wild Card Winner
- 353 Raccoon Dog
- 354 Tree Hyrax
- 355 Least Chipmunk
- 356 Island Fox
- 357 Southern African Hedgehog
- 358 Kowari
- 359 Kowari
- 360 Collared Pike
- 361 Gray-bellied Caenolestid
- 362 Kookaburra
- 363 Bank Vole
- 364 Raccoon Dog
- 365 Sebat's Short-tailed Bat
- 366 Wild Card Winner
- 367 Raccoon Dog
- 368 Tree Hyrax
- 369 Least Chipmunk
- 370 Island Fox
- 371 Southern African Hedgehog
- 372 Kowari
- 373 Kowari
- 374 Collared Pike
- 375 Gray-bellied Caenolestid
- 376 Kookaburra
- 377 Bank Vole
- 378 Raccoon Dog
- 379 Sebat's Short-tailed Bat
- 380 Wild Card Winner
- 381 Raccoon Dog
- 382 Tree Hyrax
- 383 Least Chipmunk
- 384 Island Fox
- 385 Southern African Hedgehog
- 386 Kowari
- 387 Kowari
- 388 Collared Pike
- 389 Gray-bellied Caenolestid
- 390 Kookaburra
- 391 Bank Vole
- 392 Raccoon Dog
- 393 Sebat's Short-tailed Bat
- 394 Wild Card Winner
- 395 Raccoon Dog
- 396 Tree Hyrax
- 397 Least Chipmunk
- 398 Island Fox
- 399 Southern African Hedgehog
- 400 Kowari
- 401 Kowari
- 402 Collared Pike
- 403 Gray-bellied Caenolestid
- 404 Kookaburra
- 405 Bank Vole
- 406 Raccoon Dog
- 407 Sebat's Short-tailed Bat
- 408 Wild Card Winner
- 409 Raccoon Dog
- 410 Tree Hyrax
- 411 Least Chipmunk
- 412 Island Fox
- 413 Southern African Hedgehog
- 414 Kowari
- 415 Kowari
- 416 Collared Pike
- 417 Gray-bellied Caenolestid
- 418 Kookaburra
- 419 Bank Vole
- 420 Raccoon Dog
- 421 Sebat's Short-tailed Bat
- 422 Wild Card Winner
- 423 Raccoon Dog
- 424 Tree Hyrax
- 425 Least Chipmunk
- 426 Island Fox
- 427 Southern African Hedgehog
- 428 Kowari
- 429 Kowari
- 430 Collared Pike
- 431 Gray-bellied Caenolestid
- 432 Kookaburra
- 433 Bank Vole
- 434 Raccoon Dog
- 435 Sebat's Short-tailed Bat
- 436 Wild Card Winner
- 437 Raccoon Dog
- 438 Tree Hyrax
- 439 Least Chipmunk
- 440 Island Fox
- 441 Southern African Hedgehog
- 442 Kowari
- 443 Kowari
- 444 Collared Pike
- 445 Gray-bellied Caenolestid
- 446 Kookaburra
- 447 Bank Vole
- 448 Raccoon Dog
- 449 Sebat's Short-tailed Bat
- 450 Wild Card Winner
- 451 Raccoon Dog
- 452 Tree Hyrax
- 453 Least Chipmunk
- 454 Island Fox
- 455 Southern African Hedgehog
- 456 Kowari
- 457 Kowari
- 458 Collared Pike
- 459 Gray-bellied Caenolestid
- 460 Kookaburra
- 461 Bank Vole
- 462 Raccoon Dog
- 463 Sebat's Short-tailed Bat
- 464 Wild Card Winner
- 465 Raccoon Dog
- 466 Tree Hyrax
- 467 Least Chipmunk
- 468 Island Fox
- 469 Southern African Hedgehog
- 470 Kowari
- 471 Kowari
- 472 Collared Pike
- 473 Gray-bellied Caenolestid
- 474 Kookaburra
- 475 Bank Vole
- 476 Raccoon Dog
- 477 Sebat's Short-tailed Bat
- 478 Wild Card Winner
- 479 Raccoon Dog
- 480 Tree Hyrax
- 481 Least Chipmunk
- 482 Island Fox
- 483 Southern African Hedgehog
- 484 Kowari
- 485 Kowari
- 486 Collared Pike
- 487 Gray-bellied Caenolestid
- 488 Kookaburra
- 489 Bank Vole
- 490 Raccoon Dog
- 491 Sebat's Short-tailed Bat
- 492 Wild Card Winner
- 493 Raccoon Dog
- 494 Tree Hyrax
- 495 Least Chipmunk
- 496 Island Fox
- 497 Southern African Hedgehog
- 498 Kowari
- 499 Kowari
- 500 Collared Pike
- 501 Gray-bellied Caenolestid
- 502 Kookaburra
- 503 Bank Vole
- 504 Raccoon Dog
- 505 Sebat's Short-tailed Bat
- 506 Wild Card Winner
- 507 Raccoon Dog
- 508 Tree Hyrax
- 509 Least Chipmunk
- 510 Island Fox
- 511 Southern African Hedgehog
- 512 Kowari
- 513 Kowari
- 514 Collared Pike
- 515 Gray-bellied Caenolestid
- 516 Kookaburra
- 517 Bank Vole
- 518 Raccoon Dog
- 519 Sebat's Short-tailed Bat
- 520 Wild Card Winner
- 521 Raccoon Dog
- 522 Tree Hyrax
- 523 Least Chipmunk
- 524 Island Fox
- 525 Southern African Hedgehog
- 526 Kowari
- 527 Kowari
- 528 Collared Pike
- 529 Gray-bellied Caenolestid
- 530 Kookaburra
- 531 Bank Vole
- 532 Raccoon Dog
- 533 Sebat's Short-tailed Bat
- 534 Wild Card Winner
- 535 Raccoon Dog
- 536 Tree Hyrax
- 537 Least Chipmunk
- 538 Island Fox
- 539 Southern African Hedgehog
- 540 Kowari
- 541 Kowari
- 542 Collared Pike
- 543 Gray-bellied Caenolestid
- 544 Kookaburra
- 545 Bank Vole
- 546 Raccoon Dog
- 547 Sebat's Short-tailed Bat
- 548 Wild Card Winner
- 549 Raccoon Dog
- 550 Tree Hyrax
- 551 Least Chipmunk
- 552 Island Fox
- 553 Southern African Hedgehog
- 554 Kowari
- 555 Kowari
- 556 Collared Pike
- 557 Gray-bellied Caenolestid
- 558 Kookaburra
- 559 Bank Vole
- 560 Raccoon Dog
- 561 Sebat's Short-tailed Bat
- 562 Wild Card Winner
- 563 Raccoon Dog
- 564 Tree Hyrax
- 565 Least Chipmunk
- 566 Island Fox
- 567 Southern African Hedgehog
- 568 Kowari
- 569 Kowari
- 570 Collared Pike
- 571 Gray-bellied Caenolestid
- 572 Kookaburra
- 573 Bank Vole
- 574 Raccoon Dog
- 575 Sebat's Short-tailed Bat
- 576 Wild Card Winner
- 577 Raccoon Dog
- 578 Tree Hyrax
- 579 Least Chipmunk
- 580 Island Fox
- 581 Southern African Hedgehog
- 582 Kowari
- 583 Kowari
- 584 Collared Pike
- 585 Gray-bellied Caenolestid
- 586 Kookaburra
- 587 Bank Vole
- 588 Raccoon Dog
- 589 Sebat's Short-tailed Bat
- 590 Wild Card Winner
- 591 Raccoon Dog
- 592 Tree Hyrax
- 593 Least Chipmunk
- 594 Island Fox
- 595 Southern African Hedgehog
- 596 Kowari
- 597 Kowari
- 598 Collared Pike
- 599 Gray-bellied Caenolestid
- 600 Kookaburra
- 601 Bank Vole
- 602 Raccoon Dog
- 603 Sebat's Short-tailed Bat
- 604 Wild Card Winner
- 605 Raccoon Dog
- 606 Tree Hyrax
- 607 Least Chipmunk
- 608 Island Fox
- 609 Southern African Hedgehog
- 610 Kowari
- 611 Kowari
- 612 Collared Pike
- 613 Gray-bellied Caenolestid
- 614 Kookaburra
- 615 Bank Vole
- 616 Raccoon Dog
- 617 Sebat's Short-tailed Bat
- 618 Wild Card Winner
- 619 Raccoon Dog
- 620 Tree Hyrax
- 621 Least Chipmunk
- 622 Island Fox
- 623 Southern African Hedgehog
- 624 Kowari
- 625 Kowari
- 626 Collared Pike
- 627 Gray-bellied Caenolestid
- 628 Kookaburra
- 629 Bank Vole
- 630 Raccoon Dog
- 631 Sebat's Short-tailed Bat
- 632 Wild Card Winner
- 633 Raccoon Dog
- 634 Tree Hyrax
- 635 Least Chipmunk
- 636 Island Fox
- 637 Southern African Hedgehog
- 638 Kowari
- 639 Kowari
- 640 Collared Pike
- 641 Gray-bellied Caenolestid
- 642 Kookaburra
- 643 Bank Vole
- 644 Raccoon Dog
- 645 Sebat's Short-tailed Bat
- 646 Wild Card Winner
- 647 Raccoon Dog
- 648 Tree Hyrax
- 649 Least Chipmunk
- 650 Island Fox
- 651 Southern African Hedgehog
- 652 Kowari
- 653 Kowari
- 654 Collared Pike
- 655 Gray-bellied Caenolestid
- 656 Kookaburra
- 657 Bank Vole
- 658 Raccoon Dog
- 659 Sebat's Short-tailed Bat
- 660 Wild Card Winner
- 661 Raccoon Dog
- 662 Tree Hyrax
- 663 Least Chipmunk
- 664 Island Fox
- 665 Southern African Hedgehog
- 666 Kowari
- 667 Kowari
- 668 Collared Pike
- 669 Gray-bellied Caenolestid
- 670 Kookaburra
- 671 Bank Vole
- 672 Raccoon Dog
- 673 Sebat's Short-tailed Bat
- 674 Wild Card Winner
- 675 Raccoon Dog
- 676 Tree Hyrax
- 677 Least Chipmunk
- 678 Island Fox
- 679 Southern African Hedgehog
- 680 Kowari
- 681 Kowari
- 682 Collared Pike
- 683 Gray-bellied Caenolestid
- 684 Kookaburra
- 685 Bank Vole
- 686 Raccoon Dog
- 687 Sebat's Short-tailed Bat
- 688 Wild Card Winner
- 689 Raccoon Dog
- 690 Tree Hyrax
- 691 Least Chipmunk
- 692 Island Fox
- 693 Southern African Hedgehog
- 694 Kowari
- 695 Kowari
- 696 Collared Pike
- 697 Gray-bellied Caenolestid
- 698 Kookaburra
- 699 Bank Vole
- 700 Raccoon Dog
- 701 Sebat's Short-tailed Bat
- 702 Wild Card Winner
- 703 Raccoon Dog
- 704 Tree Hyrax
- 705 Least Chipmunk
- 706 Island Fox
- 707 Southern African Hedgehog
- 708 Kowari
- 709 Kowari
- 710 Collared Pike
- 711 Gray-bellied Caenolestid
- 712 Kookaburra
- 713 Bank Vole
- 714 Raccoon Dog
- 715 Sebat's Short-tailed Bat
- 716 Wild Card Winner
- 717 Raccoon Dog
- 718 Tree Hyrax
- 719 Least Chipmunk
- 720 Island Fox
- 721 Southern African Hedgehog
- 722 Kowari
- 723 Kowari
- 724 Collared Pike
- 725 Gray-bellied Caenolestid
- 726 Kookaburra
- 727 Bank Vole
- 728 Raccoon Dog
- 729 Sebat's Short-tailed Bat
- 730 Wild Card Winner
- 731 Raccoon Dog
- 732 Tree Hyrax
- 733 Least Chipmunk
- 734 Island Fox
- 735 Southern African Hedgehog
- 736 Kowari
- 737 Kowari
- 738 Collared Pike
- 739 Gray-bellied Caenolestid
- 740 Kookaburra
- 741 Bank Vole
- 742 Raccoon Dog
- 743 Sebat's Short-tailed Bat
- 744 Wild Card Winner
- 745 Raccoon Dog
- 746 Tree Hyrax
- 747 Least Chipmunk
- 748 Island Fox
- 749 Southern African Hedgehog
- 750 Kowari
- 751 Kowari
- 752 Collared Pike
- 753 Gray-bellied Caenolestid
- 754 Kookaburra
- 755 Bank Vole
- 756 Raccoon Dog
- 757 Sebat's Short-tailed Bat
- 758 Wild Card Winner
- 759 Raccoon Dog
- 760 Tree Hyrax
- 761 Least Chipmunk
- 762 Island Fox
- 763 Southern African Hedgehog
- 764 Kowari
- 765 Kowari
- 766 Collared Pike
- 767 Gray-bellied Caenolestid
- 768 Kookaburra
- 769 Bank Vole
- 770 Raccoon Dog
- 771 Sebat's Short-tailed Bat
- 772 Wild Card Winner
- 773 Raccoon Dog
- 774 Tree Hyrax
- 775 Least Chipmunk
- 776 Island Fox
- 777 Southern African Hedgehog
- 778 Kowari
- 779 Kowari
- 780 Collared Pike
- 781 Gray-bellied Caenolestid
- 782 Kookaburra
- 783 Bank Vole
- 784 Raccoon Dog
- 785 Sebat's Short-tailed Bat
- 786 Wild Card Winner
- 787 Raccoon Dog
- 788 Tree Hyrax
- 789 Least Chipmunk
- 790 Island Fox
- 791 Southern African Hedgehog
- 792 Kowari
- 793 Kowari
- 794 Collared Pike
- 795 Gray-bellied Caenolestid
- 796 Kookaburra
- 797 Bank Vole
- 798 Raccoon Dog
- 799 Sebat's Short-tailed Bat
- 800 Wild Card Winner
- 801 Raccoon Dog
- 802 Tree Hyrax
- 803 Least Chipmunk
- 804 Island Fox
- 805 Southern African Hedgehog
- 806 Kowari
- 807 Kowari
- 808 Collared Pike
- 809 Gray-bellied Caenolestid
- 810 Kookaburra
- 811 Bank Vole
- 812 Raccoon Dog
- 813 Sebat's Short-tailed Bat
- 814 Wild Card Winner
- 815 Raccoon Dog
- 816 Tree Hyrax
- 817 Least Chipmunk
- 818 Island Fox
- 819 Southern African Hedgehog
- 820 Kowari
- 821 Kowari
- 822 Collared Pike
- 823 Gray-bellied Caenolestid
- 824 Kookaburra
- 825 Bank Vole
- 826 Raccoon Dog
- 827 Sebat's Short-tailed Bat
- 828 Wild Card Winner
- 829 Raccoon Dog
- 830 Tree Hyrax
- 831 Least Chipmunk
- 832 Island Fox
- 833 Southern African Hedgehog
- 834 Kowari
- 835 Kowari
- 836 Collared Pike
- 837 Gray-bellied Caenolestid
- 838 Kookaburra
- 839 Bank Vole
- 840 Raccoon Dog
- 841 Sebat's Short-tailed Bat
- 842 Wild Card Winner
- 843 Raccoon Dog
- 844 Tree Hyrax
- 845 Least Chipmunk
- 846 Island Fox
- 847 Southern African Hedgehog
- 848 Kowari
- 849 Kowari
- 850 Collared Pike
- 851 Gray-bellied Caenolestid
- 852 Kookaburra
- 853 Bank Vole
- 854 Raccoon Dog
- 855 Sebat's Short-tailed Bat
- 856 Wild Card Winner
- 857 Raccoon Dog
- 858 Tree Hyrax
- 859 Least Chipmunk
- 860 Island Fox
- 861 Southern African Hedgehog
- 862 Kowari
- 863 Kowari
- 864 Collared Pike
- 865 Gray-bellied Caenolestid
- 866 Kookaburra
- 867 Bank Vole
- 868 Raccoon Dog
- 869 Sebat's Short-tailed Bat
- 870 Wild Card Winner
- 871 Raccoon Dog
- 872 Tree Hyrax
- 873 Least Chipmunk
- 874 Island Fox
- 875 Southern African Hedgehog
- 876 Kowari
- 877 Kowari
- 878 Collared Pike
- 879 Gray-bellied Caenolestid
- 880 Kookaburra
- 881 Bank Vole
- 882 Raccoon Dog
- 883 Sebat's Short-tailed Bat
- 884 Wild Card Winner
- 885 Raccoon Dog
- 886 Tree Hyrax
- 887 Least Chipmunk
- 888 Island Fox
- 8

Bhavana Tiwari
Your Name Goes Here

2020

March

Mammal Madness

mammalssuck.blogspot.com

MMM created and directed by
Prof Katie Hinde, Arizona State University
v1.0 Eng Bracket design by Will Nickley

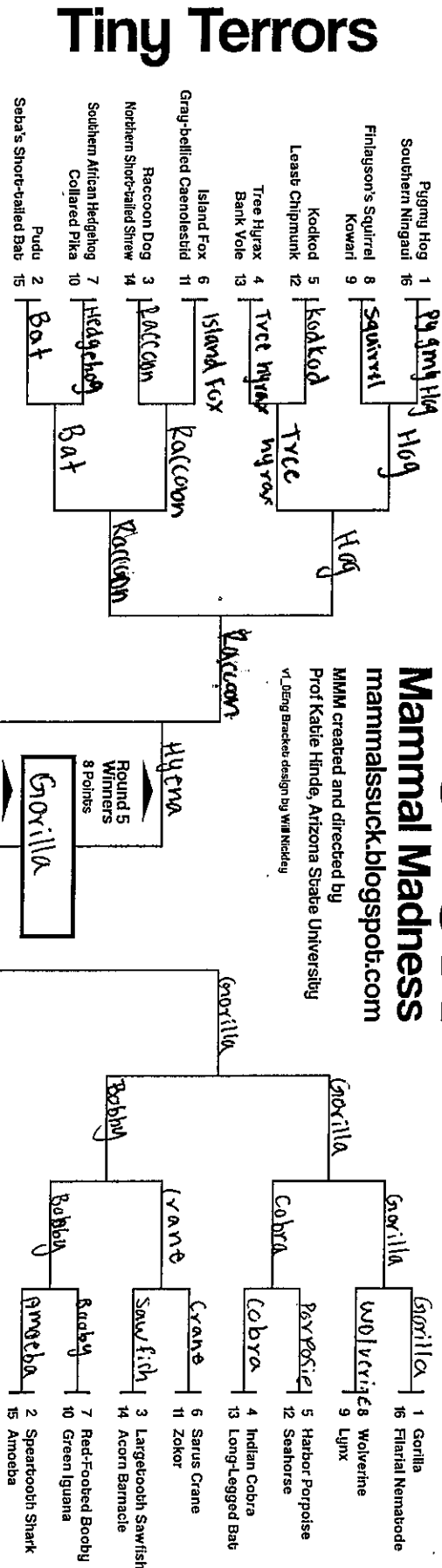

Double Trouble

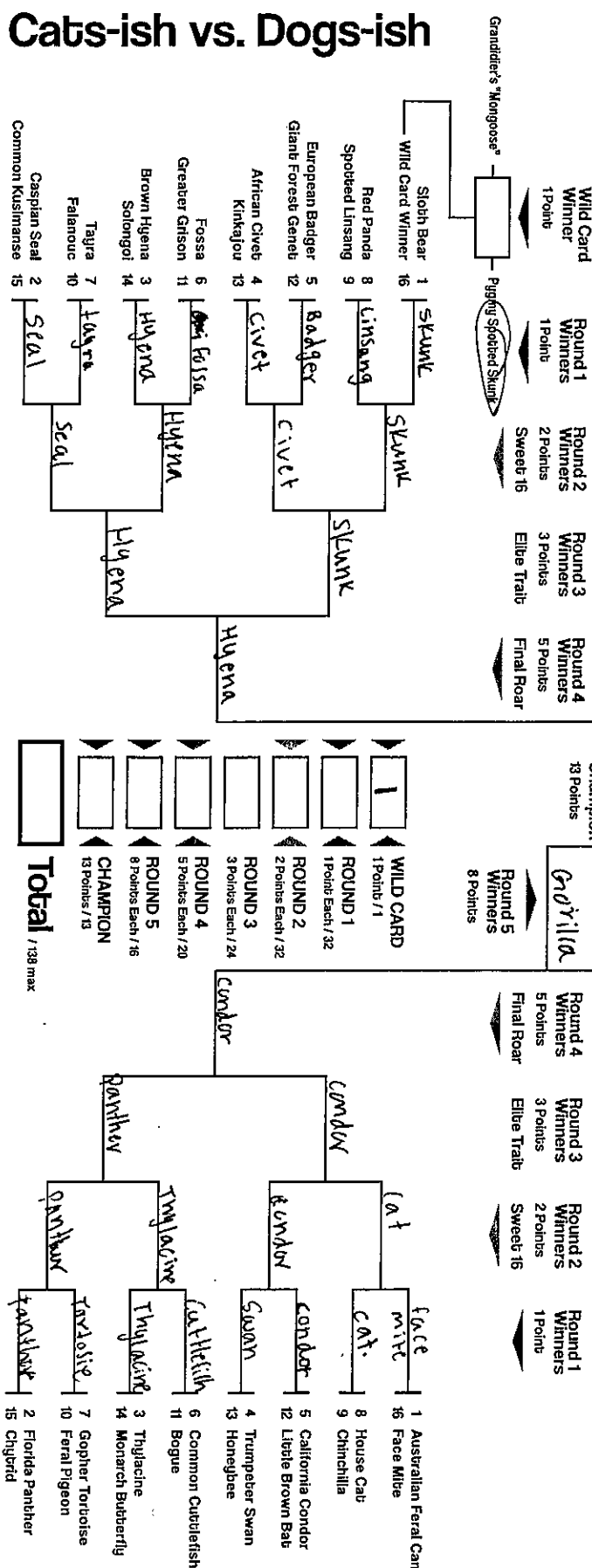

AnthropoSCENE

1 WILD CARD
1 Point / 1
 ROUND 1
1 Point Each / 32
 ROUND 2
2 Points Each / 32
 ROUND 3
3 Points Each / 24
 ROUND 4
5 Points Each / 20
 ROUND 5
8 Points Each / 16
 CHAMPION
13 Points / 13
 Total / 138 max

- 1 Australian Feral Camel
- 2 Florida Panther
- 3 Thyacine
- 4 Trumpeter Swan
- 5 California Condor
- 6 Common Cuttlefish
- 7 Gopher Tortoise
- 8 House Cat
- 9 Chinchilla
- 10 Feral Pigeon
- 11 Bogue
- 12 Little Brown Bat
- 13 Honeybee
- 14 Monarch Butterfly
- 15 Face Mite